



## NBSN95 NB-IoT Sensor Node User Manual

Document Version: 2.0.0

Image Version: NBSN95-v110

Version	Description	Date
1.0	Release	2020-Aug-05
1.0.1	Fix typo of source code link, Added mode 6	
1.0.2	Join UDP mode upload, close NB echo function, optimize serial port response, serial port output real-time time is changed to system running time	2020-Nov-17
1.0.3	Add faq of transmit protocol.	
1.1.0	Re-write structure for NB-IoT Add more AT Commands. Add MQTT and TCP protocol, improve CoAP and UDP upload. Remove resend after fail. Change TDC time default to 60 minutes. Change the version number to integer, payload will also include version number now	2021-Jan-5
1.1.1	Add detail description of switch/jumpers, add VDD/5V description	2021-Feb-4
1.1.2	Add notice for MQTT	2021-Mar-3
1.1.3	Add Set Up notice for CoAP	
2.0.0	Add NBSN95A	2021-Jun-6

1.	Introduction	4
1.1	What is NBSN95 NB-IoT Sensor Node	4
1.2	Specifications	5
1.3	Features	5
1.4	Applications	6
1.5	Pin Definitions & Switch	7
1.5.1	Jumper JP2	8
1.5.2	BOOT MODE / SW1	8
1.5.3	Reset Button	8
1.5.4	LED	8
1.6	Hole Option	9
2.	Use NBSN95 to communicate with IoT Server	10
2.1	How it works	10
2.2	Configure the NBSN95	11
2.2.1	Power On NBSN95	11
2.2.2	Test Requirement	11
2.2.3	Insert SIM card	12
2.2.4	Connect USB – TTL to NBSN95 to configure it	12
2.2.5	Use CoAP protocol to uplink data	13
2.2.6	Use UDP protocol to uplink data(Default protocol)	15
2.2.7	Use MQTT protocol to uplink data	18
2.2.8	Use TCP protocol to uplink data	19
2.2.9	Change Update Interval	20
2.3	Working Mode & Uplink Payload	21
2.3.1	CFGMOD=1 (Default Mode)	22
2.3.2	CFGMOD=2 (Distance Mode)	23
2.3.3	CFGMOD=3 (3 ADC + I2C)	24
2.3.4	CFGMOD=4 (3 x DS18B20)	26
2.3.5	CFGMOD=5(Weight Measurement by HX711)	27
2.3.6	CFGMOD=6(Counting mode)	29
2.4	Payload Explanation and Sensor Interface	31
2.4.1	Device ID	31
2.4.2	Version Info	31
2.4.3	Battery Info	31
2.4.4	Signal Strength	31
2.4.5	Temperature (DS18B20)	31
2.4.6	Digital Input	32
2.4.7	Analogue Digital Converter (ADC)	32
2.4.8	Digital Interrupt	34
2.4.9	I2C Interface (SHT20)	35
2.4.10	Distance Reading	36
2.4.11	Ultrasonic Sensor	36
2.4.12	+5V Output	38
2.4.13	Weigh Sensor HX711	38
2.5	Downlink Payload	39
2.6	Firmware Change Log	40

---

2.7	Use VDD or +5V to Power External Sensor	40
2.8	Battery Analysis	40
2.8.1	Battery Type	40
2.8.2	Power consumption Analyze	41
2.8.3	Battery Note	41
2.8.4	Replace the battery	41
3.	Access NB-IoT Module	41
4.	Using the AT Commands	43
4.1	Access AT Commands	43
5.	Developer Guide	44
5.1	Get and compile Software	44
5.2	Get hardware source	44
6.	FAQ	45
6.1	How to Upgrade Firmware	45
7.	Trouble Shooting	46
7.1	Connection problem when uploading firmware.	46
7.2	AT Command input doesn't work	46
8.	Order Info	47
9.	Packing Info	47
10.	Support	47

## 1. Introduction

### 1.1 What is NBSN95 NB-IoT Sensor Node

NBSN95 is a Long Range NB-IoT Sensor Node. It is designed for **outdoor data logging** and powered by **Li/SOCI2 battery** for long term use and secure data transmission. It is designed to facilitate developers to quickly deploy industrial level NB-IoT solutions. It helps users to turn the idea into a practical application and make the Internet of Things a reality. It is easy to program, create and connect your things everywhere.

**NarrowBand-Internet of Things (NB-IoT)** is a standards-based low power wide area (LPWA) technology developed to enable a wide range of new IoT devices and services. NB-IoT significantly improves the power consumption of user devices, system capacity and spectrum efficiency, especially in deep coverage.

**NBSN95** uses STM32I0x chip from ST, STMLOx is the **ultra-low-power** STM32L072xx microcontrollers incorporate the connectivity power of the universal serial bus (USB 2.0 crystal-less) with the high-performance ARM® Cortex®-M0+ 32-bit RISC core operating at a 32 MHz frequency, a memory protection unit (MPU), high-speed embedded memories (192 Kbytes of Flash program memory, 6 Kbytes of data EEPROM and 20 Kbytes of RAM) plus an extensive range of enhanced I/Os and peripherals.

NBSN95 is an **open source product**, it is based on the STM32Cube HAL drivers and lots of libraries can be found in ST site for rapid development.

#### NBSN95 in a NB-IoT Network

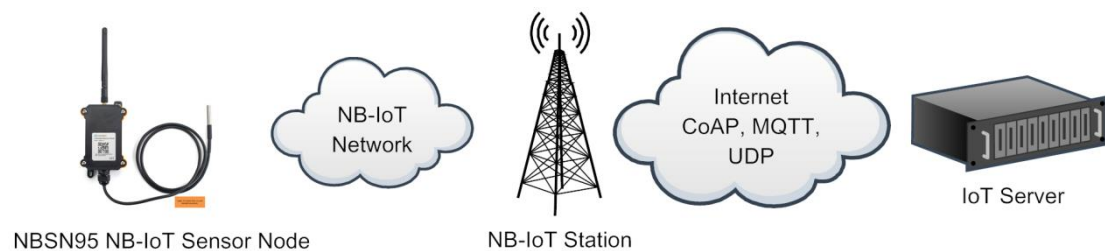

## 1.2 Specifications

### Micro Controller:

- STM32L072CZT6 MCU
- MCU: STM32L072CZT6
- Flash: 192KB
- RAM: 20KB
- EEPROM: 6KB
- Clock Speed: 32Mhz

### Common DC Characteristics:

- Supply Voltage: 2.1v ~ 3.6v
- Operating Temperature: -40 ~ 85°C
- I/O pins: Refer to STM32L072 datasheet

### NB-IoT Spec:

- - B1 @H-FDD: 2100MHz
- - B3 @H-FDD: 1800MHz
- - B8 @H-FDD: 900MHz
- - B5 @H-FDD: 850MHz
- - B20 @H-FDD: 800MHz
- - B28 @H-FDD: 700MHz

### Battery:

- Li/SOCI2 un-chargeable battery
- Capacity: 8500mAh
- Self Discharge: <1% / Year @ 25°C
- Max continuously current: 130mA
- Max boost current: 2A, 1 second

### Power Consumption

- STOP Mode: 10uA @ 3.3v
- Max transmit power: 350mA@3.3v

## 1.3 Features

- STM32L072CZT6 MCU
- NB-IoT Bands: B1/B3/B8/B5/B20/B28 @H-FDD
- Pre-load bootloader on USART1/USART2
- MDK-ARM Version 5.24a IDE
- I2C, LPUSART1, USB, SPI2
- 3x12bit ADC, 1x12bit DAC
- 20xDigital I/O
- Open-source hardware / software
- IP66 Waterproof Enclosure
- Ultra-Low Power consumption
- AT Commands to change parameters
- Micro SIM card slot for NB-IoT SIM
- 8500mAh Battery for long term use

## 1.4 Applications

- Smart Buildings & Home Automation
- Logistics and Supply Chain Management
- Smart Metering
- Smart Agriculture
- Smart Cities
- Smart Factory

## 1.5 Pin Definitions & Switch

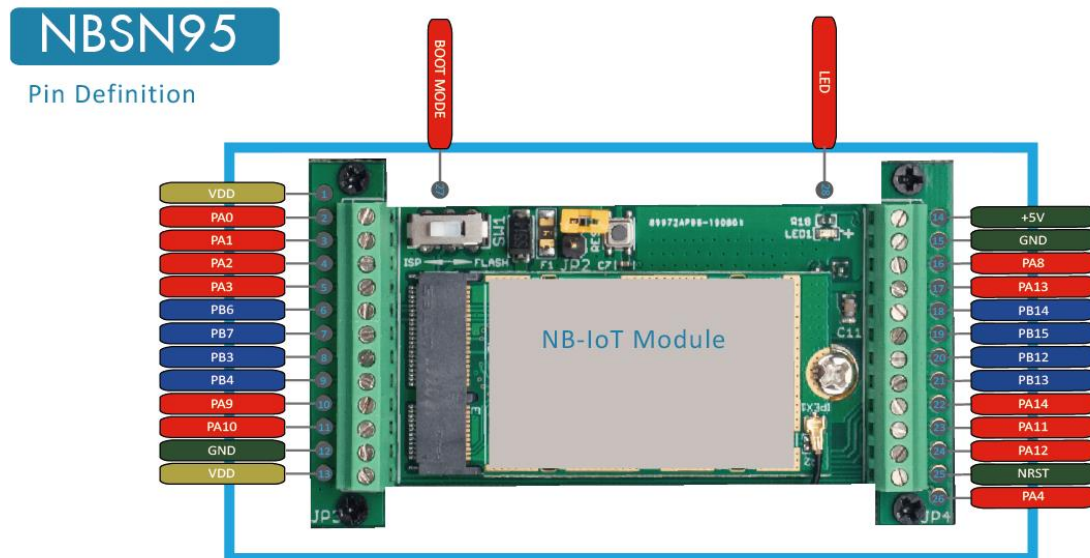

No.	Signal	Direction	Function	Remark
1	VCC(2.9V)	OUTPUT	VCC	Directly connect to main power for board
2	PA0	In/Out	Directly from STM32 chip	Used as ADC in NBSN95 image
3	PA1	In/Out	Directly from STM32 chip	
4	PA2	In/Out	Directly from STM32 chip, 10k pull up to VCC	Used as UART_TXD in NBSN95 image
5	PA3	In/Out	Directly from STM32 chip, 10k pull up to VCC	Used as UART_RXD in NBSN95 image
6	PB6	In/Out	Directly from STM32 chip, 10k pull up to VCC	
7	PB7	In/Out	Directly from STM32 chip, 10k pull up to VCC	
8	PB3	In/Out	Directly from STM32 chip, 10k pull up to VCC	
9	PB4	In/Out	Directly from STM32 chip	
10	PA9	In/Out	Directly from STM32 chip, 10k pull up to VCC	
11	PA10	In/Out	Directly from STM32 chip, 10k pull up to VCC	
12	GND		Ground	
13	VCC(2.9V)	OUTPUT	VCC	Directly connect to main power for board
14	Jumper		Power on/off jumper	
15	PA4	In/Out	Directly from STM32 chip	
16	NRST	In	Reset MCU	

17	PA12	In/Out	Directly from STM32 chip	
18	PA11	In/Out	Directly from STM32 chip	
19	PA14	In/Out	Directly from STM32 chip	
20	PB13	In/Out	Directly from STM32 chip	
21	PB12	In/Out	Directly from STM32 chip	
22	PB15	In/Out	Directly from STM32 chip	
23	PB14	In/Out	Directly from STM32 chip	
24	PA13	In/Out	Directly from STM32 chip	
25	PA8	In/Out	Directly from STM32 chip	Default use to turn on/off LED1 in NBSN95 image
26	GND		Ground	
27	+5V	Out	5v output power	Controlled by PB5(Low to Enable, High to Disable)
28	LED1		Controlled by PA8	Blink on transmit
29	BOOT MODE		Configure device in working mode or ISP program mode	Flash: Normal Working mode and send AT Commands ISP: UART Program Mode
30	NRST	In	Reset MCU	

### 1.5.1 Jumper JP2

Power on Device when put this jumper.

### 1.5.2 BOOT MODE / SW1

- 1) ISP: upgrade mode, device won't have any signal in this mode. but ready for upgrade firmware. LED won't work. Firmware won't run.
- 2) Flash: work mode, device starts to work and send out console output for further debug

### 1.5.3 Reset Button

Press to reboot the device.

### 1.5.4 LED

It will flash:

- 1) When boot the device in flash mode
- 2) Send an uplink packet



## 1.6 Hole Option

The NBSN95 provides different hole size options for different size sensor cable. The options provided are M12, M16. The definition is as below:



多项国际质量认证



品质保证放心使用

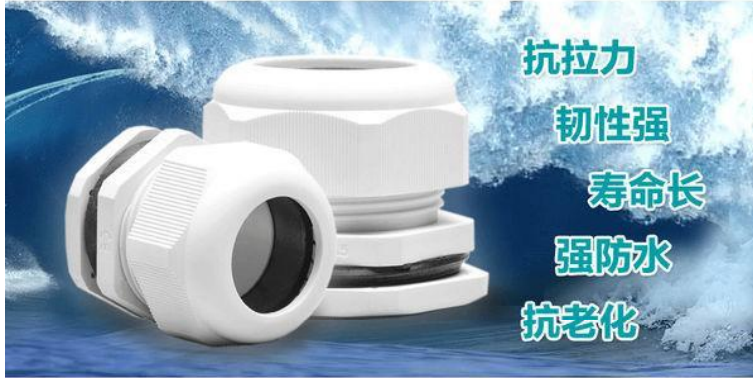

### 产品结构 Structure

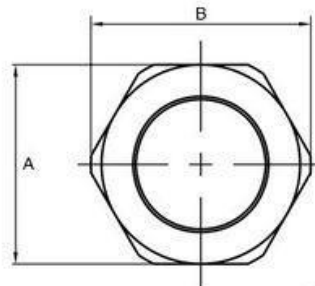
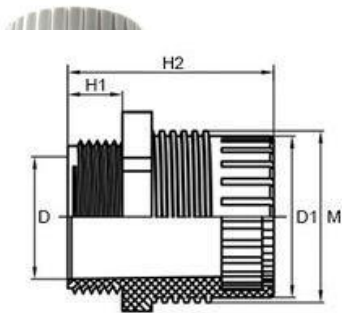
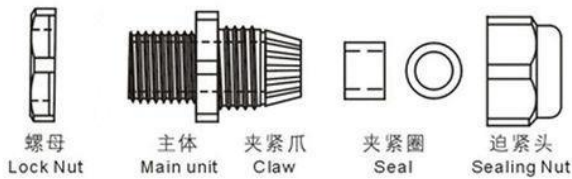

单位: mm

MODEL	H1	H2	M	M1	D	D1	A	B
M12*1.5	8	28.3	12.0	12.0	10.4	8.5 ± 0.2	16 ± 0.2	18 ± 0.2
M16*1.5	8	30.7	15.1	16.0	13.5	10.9 ± 0.2	18.8 ± 0.2	20.6 ± 0.2
M20*1.5	9	34.0	20.2	20.0	18.7	16.2 ± 0.2	22.8 ± 0.2	25.2 ± 0.2

## 2. Use NBSN95 to communicate with IoT Server

### 2.1 How it works

The NBSN95 is equipped with a NB-IoT module, the pre-loaded firmware in NBSN95 will get environment data from sensors and send the value to local NB-IoT network via the NB-IoT module. The NB-IoT network will forward this value to IoT server via the protocol defined by NBSN95.

The diagram below shows the working flow in default firmware of NBSN95:

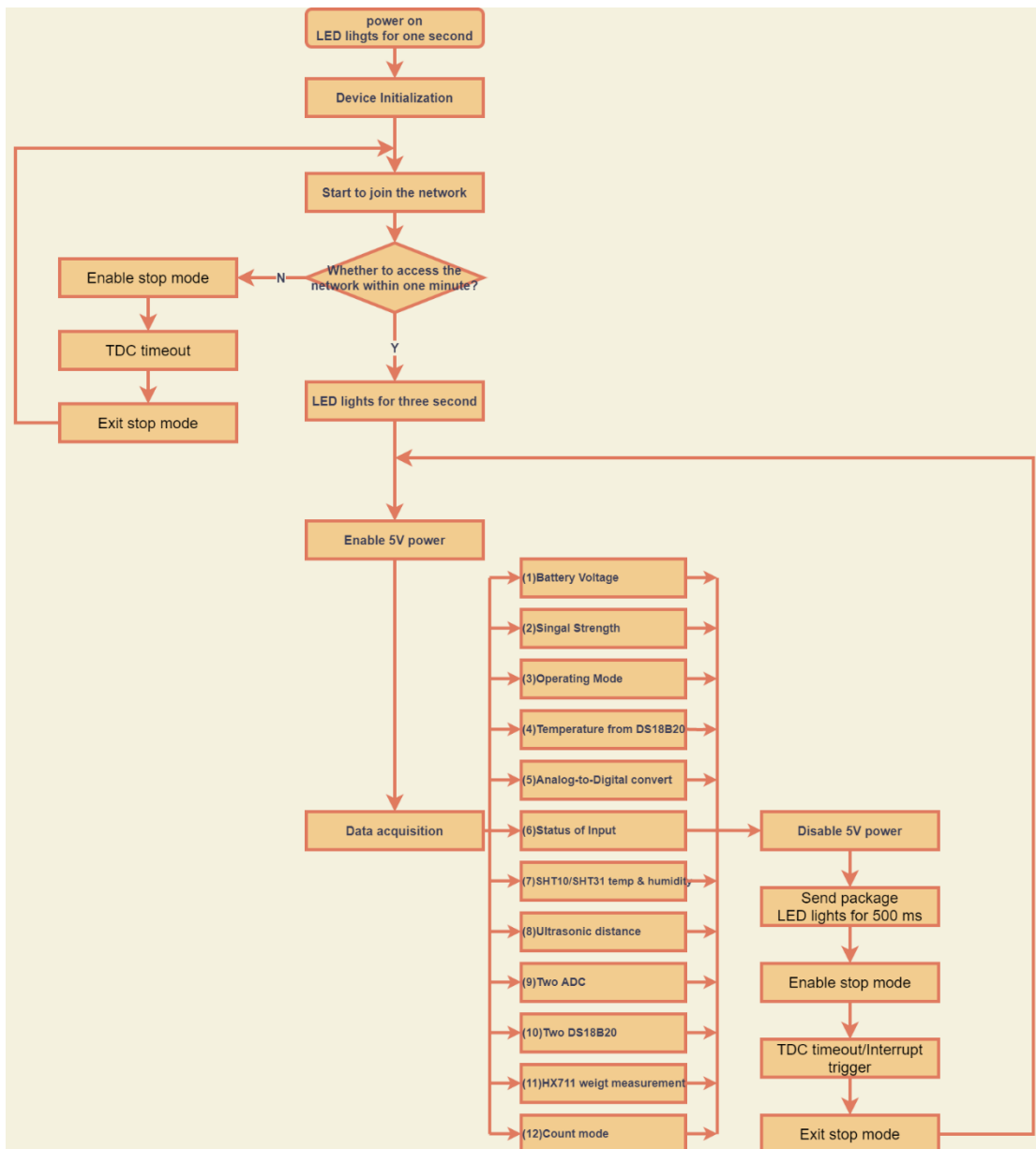

## 2.2 Configure the NBSN95

### 2.2.1 Power On NBSN95

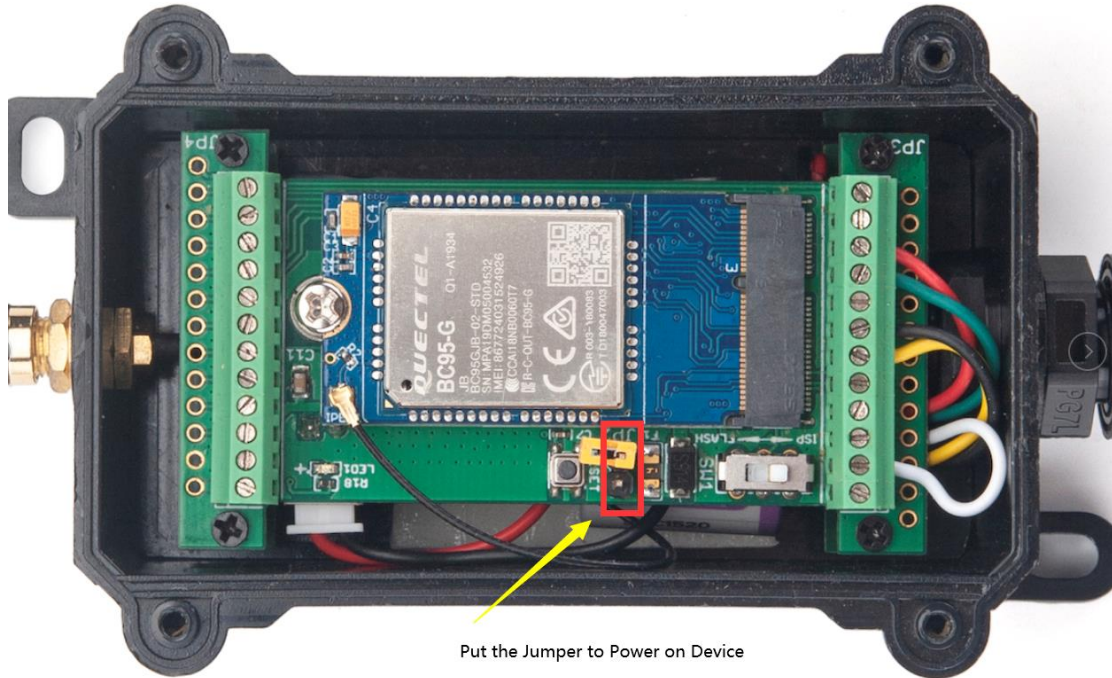

### 2.2.2 Test Requirement

To use NBSN95 in your city, make sure meet below requirements:

- ✓ Your local operator has already distributed a NB-IoT Network there.
- ✓ The local NB-IoT network used the band that NBSN95 supports.
- ✓ Your operator is able to distribute the data received in their NB-IoT network to your IoT server.

Below figure shows our testing structure. Here we have NB-IoT network coverage by China Mobile, the band they use is B8. The NBSN95 will use CoAP(120.24.4.116:5683) or raw UDP(120.24.4.116:5601) or MQTT(120.24.4.116:1883) or TCP(120.24.4.116:5600) protocol to send data to the test server

#### NBSN95 network example in Dragino office

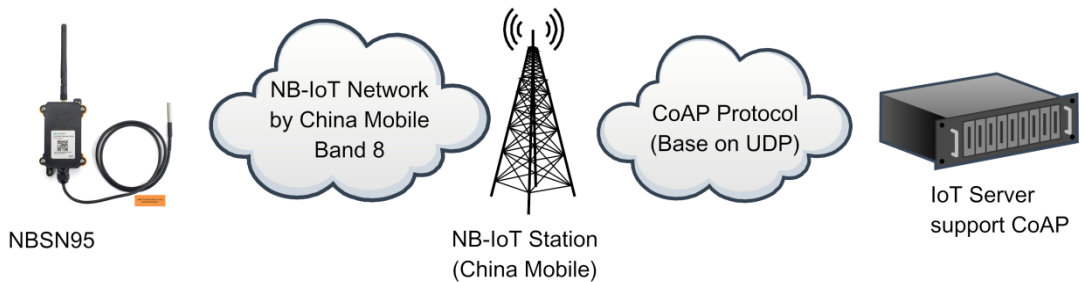

### 2.2.3 Insert SIM card

Insert the NB-IoT Card get from your provider.

User need to take out the NB-IoT module and insert the SIM card like below:



### 2.2.4 Connect USB – TTL to NBSN95 to configure it

User need to configure NBSN95 via serial port to set the **Server Address / Uplink Topic** to define where and how-to uplink packets. NBSN95 support AT Commands, user can use a USB to TTL adapter to connect to NBSN95 and use AT Commands to configure it, as below.

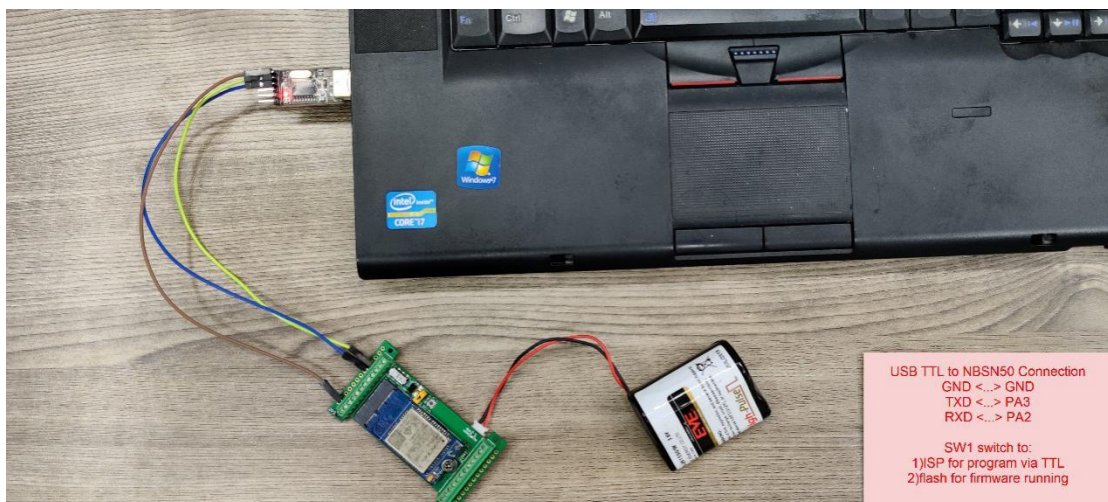

In the PC, use below serial tool settings:

- ✓ Baud: **9600**
- ✓ Data bits: **8**
- ✓ Stop bits: **1**
- ✓ Parity: **None**
- ✓ Flow Control: **None**

Make sure the switch is in FLASH position, then power on device by connecting the jumper on NBSN95. NBSN95 will output system info once power on as below, we can enter the **password: 12345678** to access AT Command input. Note( If 12345678 doesn't work, please try to enter 0 for the password)

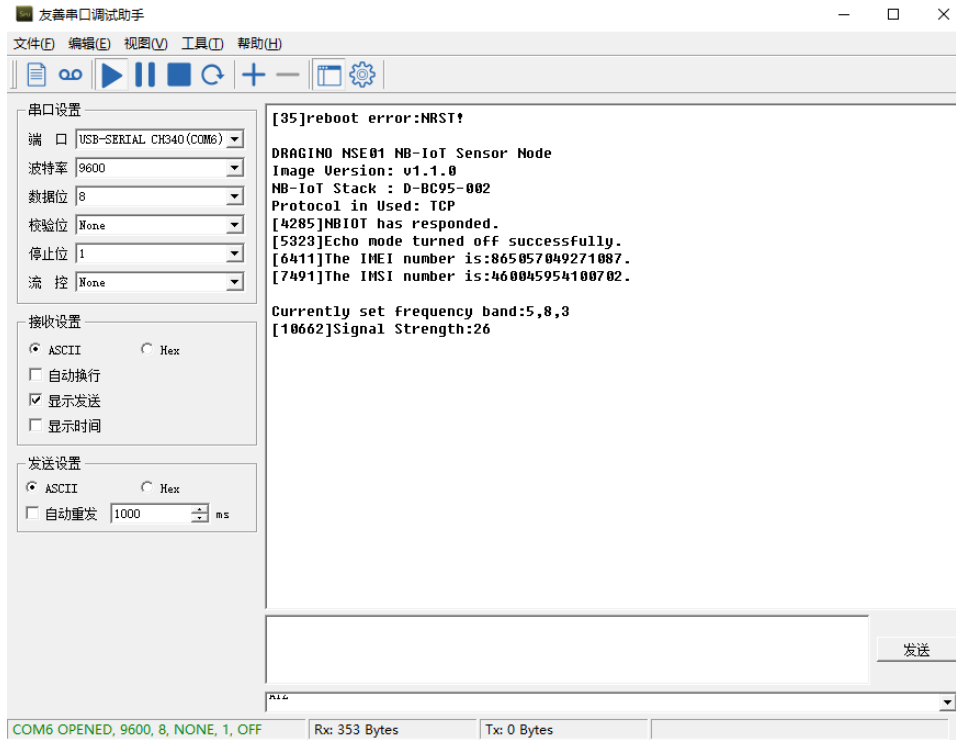

Note: the valid AT Commands can be found at:

<http://www.dragino.com/downloads/index.php?dir=NB-IoT/NBSN95/>

### 2.2.5 Use CoAP protocol to uplink data

Note: if you don't have CoAP server, you can refer this link to set up one:

[http://wiki.dragino.com/index.php?title=Set\\_up\\_CoAP\\_Server](http://wiki.dragino.com/index.php?title=Set_up_CoAP_Server)

Use below commands:

- **AT+PRO=1** // Set to use CoAP protocol to uplink
- **AT+SERVADDR=120.24.4.116,5683** // to set CoAP server address and port
- **AT+URI=5,11,"mqtt",11,"coap",12,"0",15,"c=text1",23,"0"** //Set COAP resource path

For parameter description, please refer to AT command set

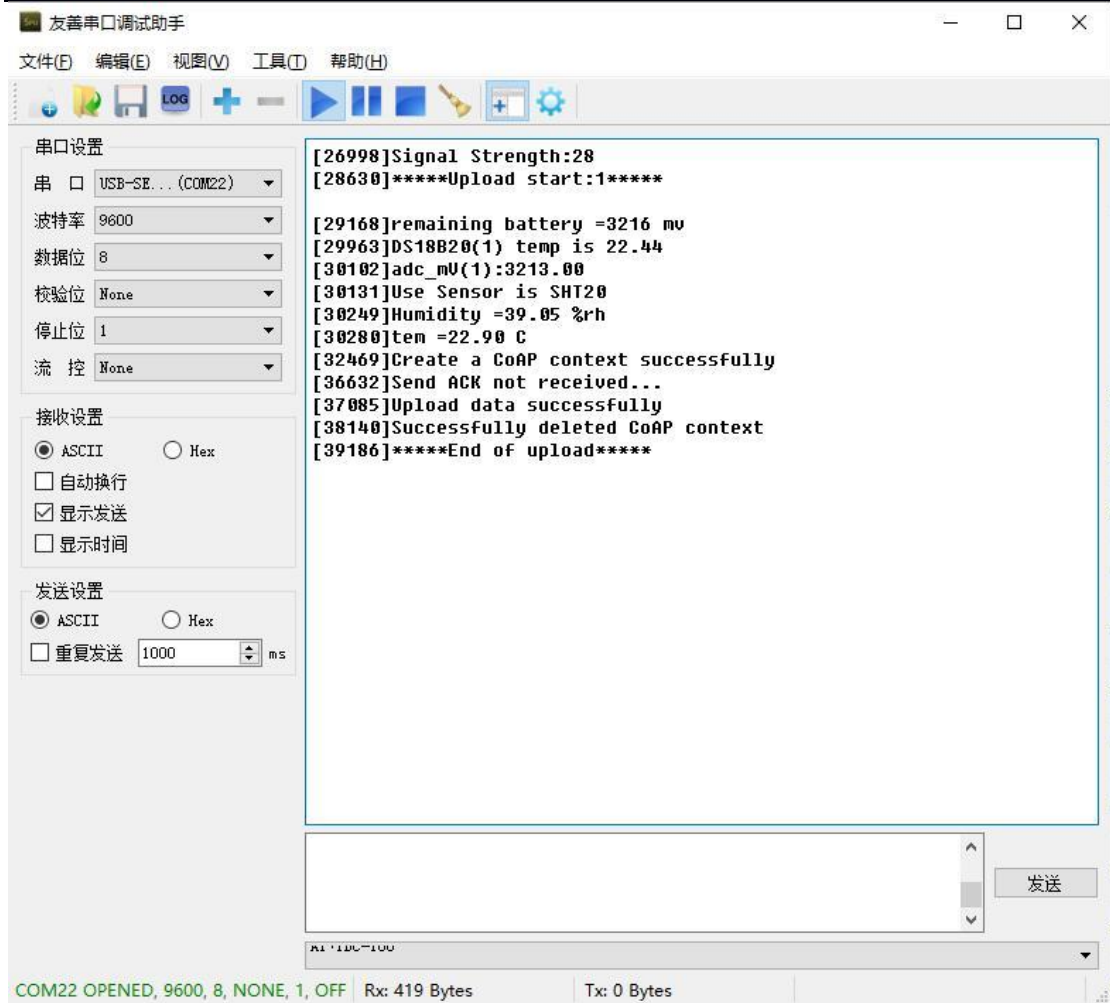

After configure the server address and **reset the device** (via AT+ATZ ), NBSN95 will start to uplink sensor values to CoAP server.

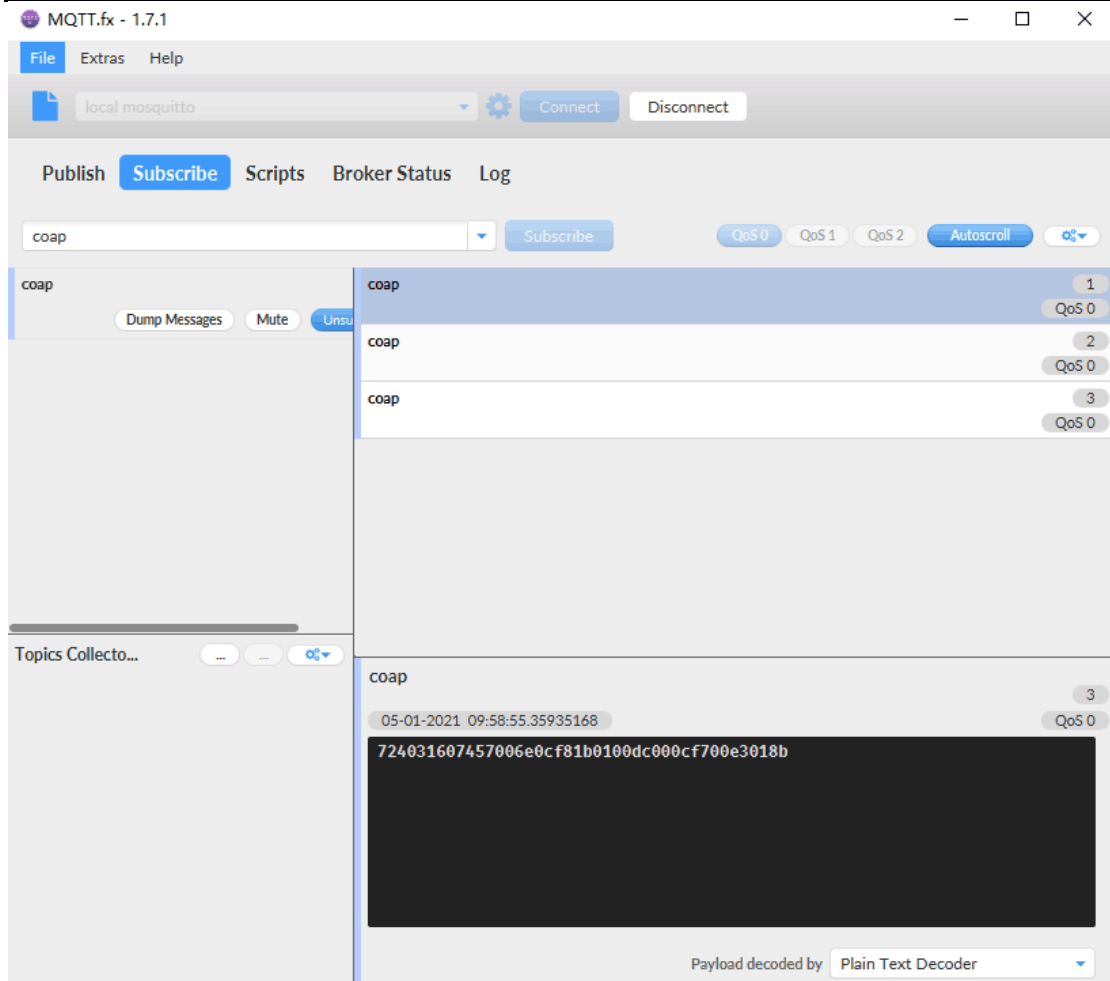

### 2.2.6 Use UDP protocol to uplink data(Default protocol)

This feature is supported since firmware version v1.0.1

- **AT+PRO=2** // Set to use UDP protocol to uplink
- **AT+SERVADDR=120.24.4.116,5601** // to set UDP server address and port
- **AT+CFM=1** //If the server does not respond, this command is unnecessary

友善串口调试助手

文件(F) 编辑(E) 视图(V) 工具(T) 帮助(H)

串口设置

串口 USB-SE... (COM22)

波特率 9600

数据位 8

校验位 None

停止位 1

流控 None

接收设置

ASCII  Hex

自动换行

显示发送

显示时间

发送设置

ASCII  Hex

重复发送 1000 ms

[74554]Signal Strength:27  
[76186]\*\*\*\*\*Upload start:3\*\*\*\*\*

[76724]remaining battery =3205 mv  
[77519]DS18B20(1) temp is 22.56  
[77658]adc\_mV(1):3204.00  
[77687]Use Sensor is SHT20  
[77805]Humidity =39.26 %rh  
[77836]tem =23.29 C  
[78895]Open UDP port successfully  
[83038]Sending data...  
[85668]Datagram is sent by RF  
[87739]Close the port successfully  
[88779]\*\*\*\*\*End of upload\*\*\*\*\*  
Password timeout

发送

COM22 OPENED, 9600, 8, NONE, 1, OFF | Rx: 414 Bytes | Tx: 0 Bytes



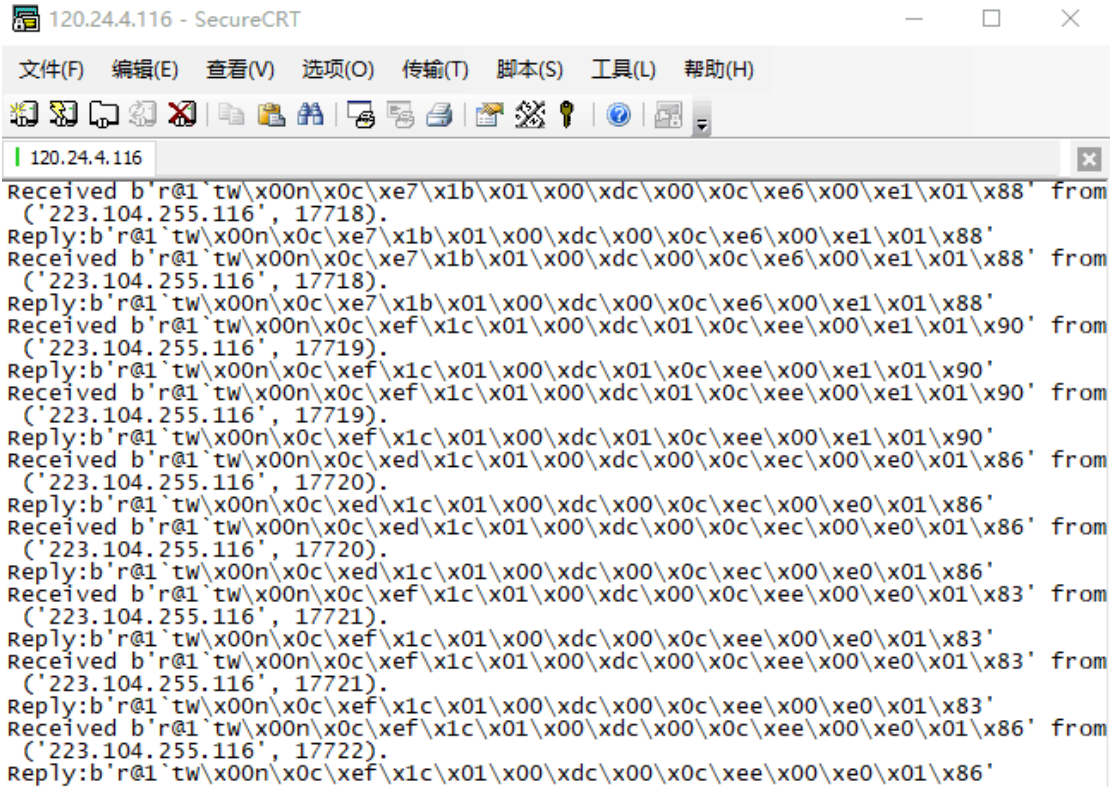

```
120.24.4.116 - SecureCRT
文件(F) 编辑(E) 查看(V) 选项(O) 传输(T) 脚本(S) 工具(L) 帮助(H)
120.24.4.116
Received b'r@1`tw\x00n\x0c\xe7\x1b\x01\x00\xdc\x00\x0c\xe6\x00\xe1\x01\x88' from
('223.104.255.116', 17718).
Reply:b'r@1`tw\x00n\x0c\xe7\x1b\x01\x00\xdc\x00\x0c\xe6\x00\xe1\x01\x88'
Received b'r@1`tw\x00n\x0c\xe7\x1b\x01\x00\xdc\x00\x0c\xe6\x00\xe1\x01\x88' from
('223.104.255.116', 17718).
Reply:b'r@1`tw\x00n\x0c\xe7\x1b\x01\x00\xdc\x00\x0c\xe6\x00\xe1\x01\x88'
Received b'r@1`tw\x00n\x0c\xef\x1c\x01\x00\xdc\x01\x0c\xee\x00\xe1\x01\x90' from
('223.104.255.116', 17719).
Reply:b'r@1`tw\x00n\x0c\xef\x1c\x01\x00\xdc\x01\x0c\xee\x00\xe1\x01\x90'
Received b'r@1`tw\x00n\x0c\xef\x1c\x01\x00\xdc\x01\x0c\xee\x00\xe1\x01\x90' from
('223.104.255.116', 17719).
Reply:b'r@1`tw\x00n\x0c\xef\x1c\x01\x00\xdc\x01\x0c\xee\x00\xe1\x01\x90'
Received b'r@1`tw\x00n\x0c\xed\x1c\x01\x00\xdc\x00\x0c\xec\x00\xe0\x01\x86' from
('223.104.255.116', 17720).
Reply:b'r@1`tw\x00n\x0c\xed\x1c\x01\x00\xdc\x00\x0c\xec\x00\xe0\x01\x86'
Received b'r@1`tw\x00n\x0c\xed\x1c\x01\x00\xdc\x00\x0c\xec\x00\xe0\x01\x86' from
('223.104.255.116', 17720).
Reply:b'r@1`tw\x00n\x0c\xed\x1c\x01\x00\xdc\x00\x0c\xec\x00\xe0\x01\x86'
Received b'r@1`tw\x00n\x0c\xef\x1c\x01\x00\xdc\x00\x0c\xee\x00\xe0\x01\x83' from
('223.104.255.116', 17721).
Reply:b'r@1`tw\x00n\x0c\xef\x1c\x01\x00\xdc\x00\x0c\xee\x00\xe0\x01\x83'
Received b'r@1`tw\x00n\x0c\xef\x1c\x01\x00\xdc\x00\x0c\xee\x00\xe0\x01\x83' from
('223.104.255.116', 17721).
Reply:b'r@1`tw\x00n\x0c\xef\x1c\x01\x00\xdc\x00\x0c\xee\x00\xe0\x01\x83'
Received b'r@1`tw\x00n\x0c\xef\x1c\x01\x00\xdc\x00\x0c\xee\x00\xe0\x01\x86' from
('223.104.255.116', 17722).
Reply:b'r@1`tw\x00n\x0c\xef\x1c\x01\x00\xdc\x00\x0c\xee\x00\xe0\x01\x86'
```

### 2.2.7 Use MQTT protocol to uplink data

This feature is supported since firmware version v110, it supports only plain MQTT now it doesn't support TLS and other related encryption.

- **AT+PRO=3** // Set to use MQTT protocol to uplink
- **AT+SERVADDR=120.24.4.116,1883** // to set MQTT server address and port
- **AT+CLIENT=CLIENT** //Set up the CLIENT of MQTT
- **AT+UNAME=UNAME** //Set the username of MQTT
- **AT+PWD=PWD** //Set the password of MQTT
- **AT+PUBTOPIC=f9527** //Set the sending topic of MQTT
- **AT+SUBTOPIC=s9527** //Set the subscription topic of MQTT

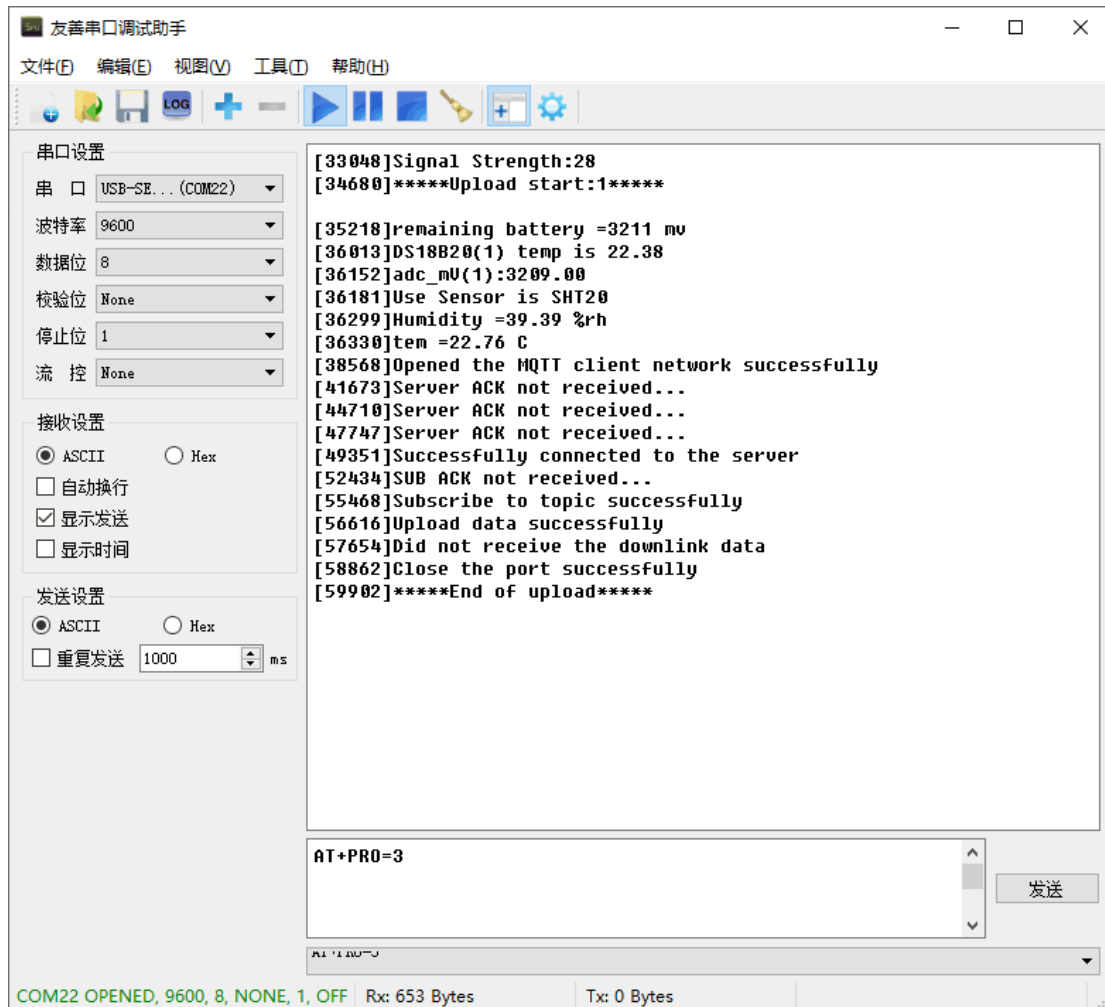

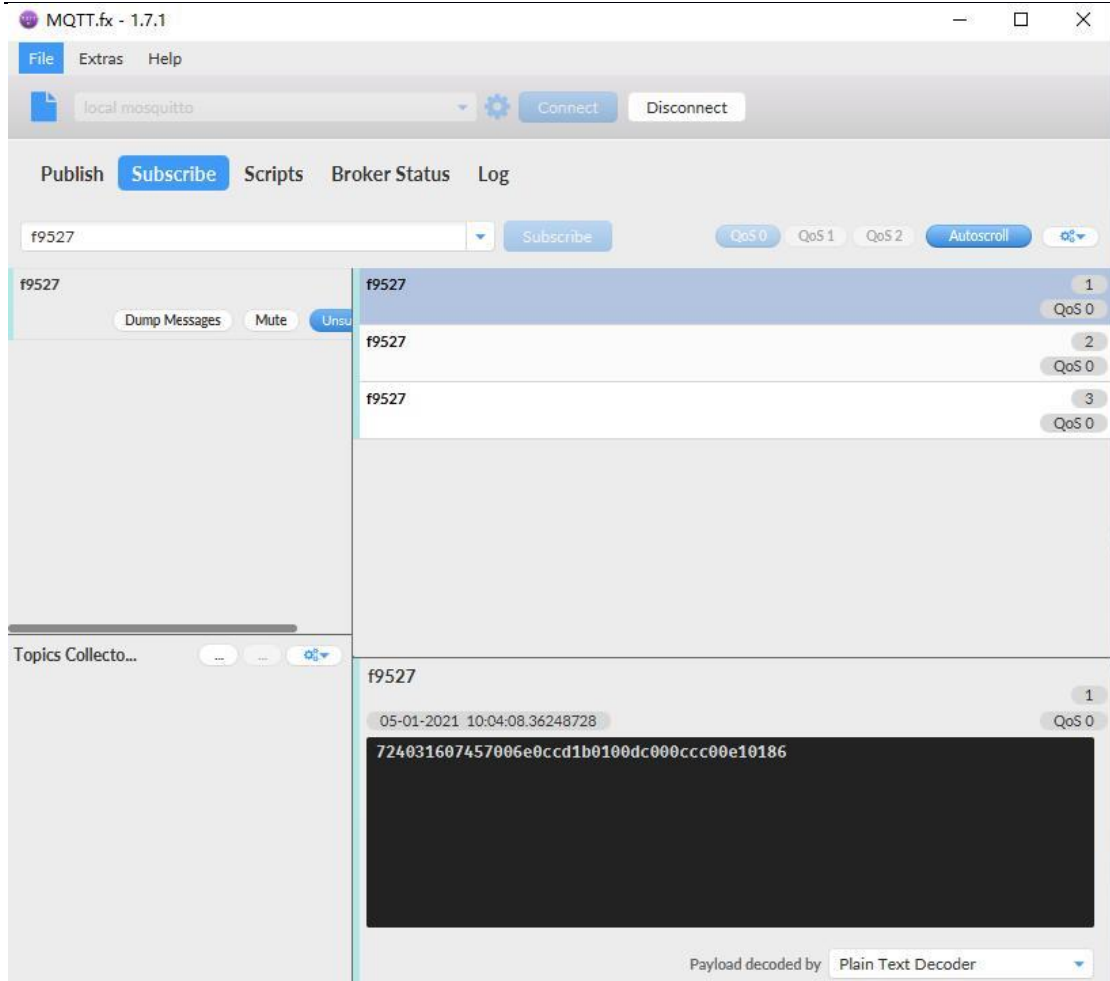

请加入 Subscribe Topic 的效果图，

To save battery life, NBSN95 will establish a subscription before each uplink and close the subscription 3 seconds after uplink successful. Any downlink commands from server will only arrive during the subscription period.

关闭订阅的时间待定

MQTT protocol has a much high power consumption compare vs UDP / CoAP protocol. Please check the power analyze document and adjust the uplink period to a suitable interval.

### 2.2.8 Use TCP protocol to uplink data

This feature is supported since firmware version v110

- **AT+PRO=4** // Set to use TCP protocol to uplink
- **AT+SERVADDR=120.24.4.116,5600** // to set TCP server address and port

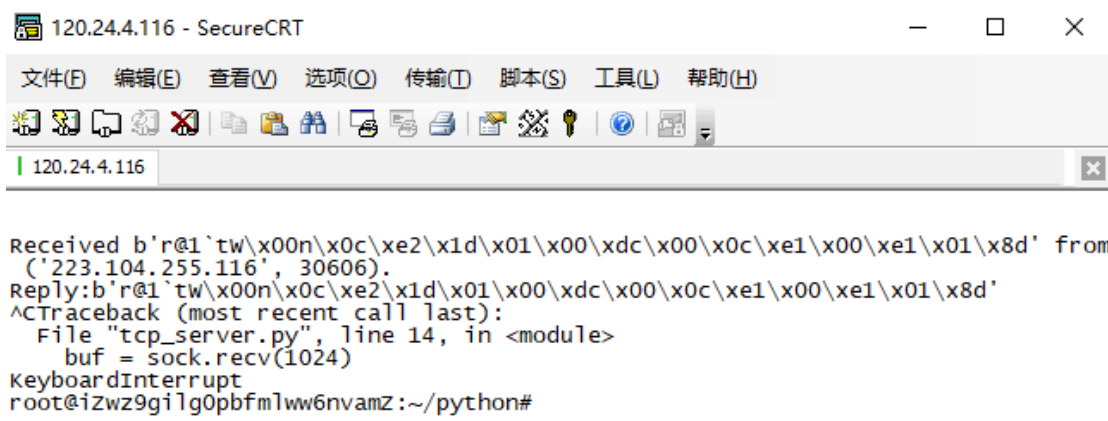
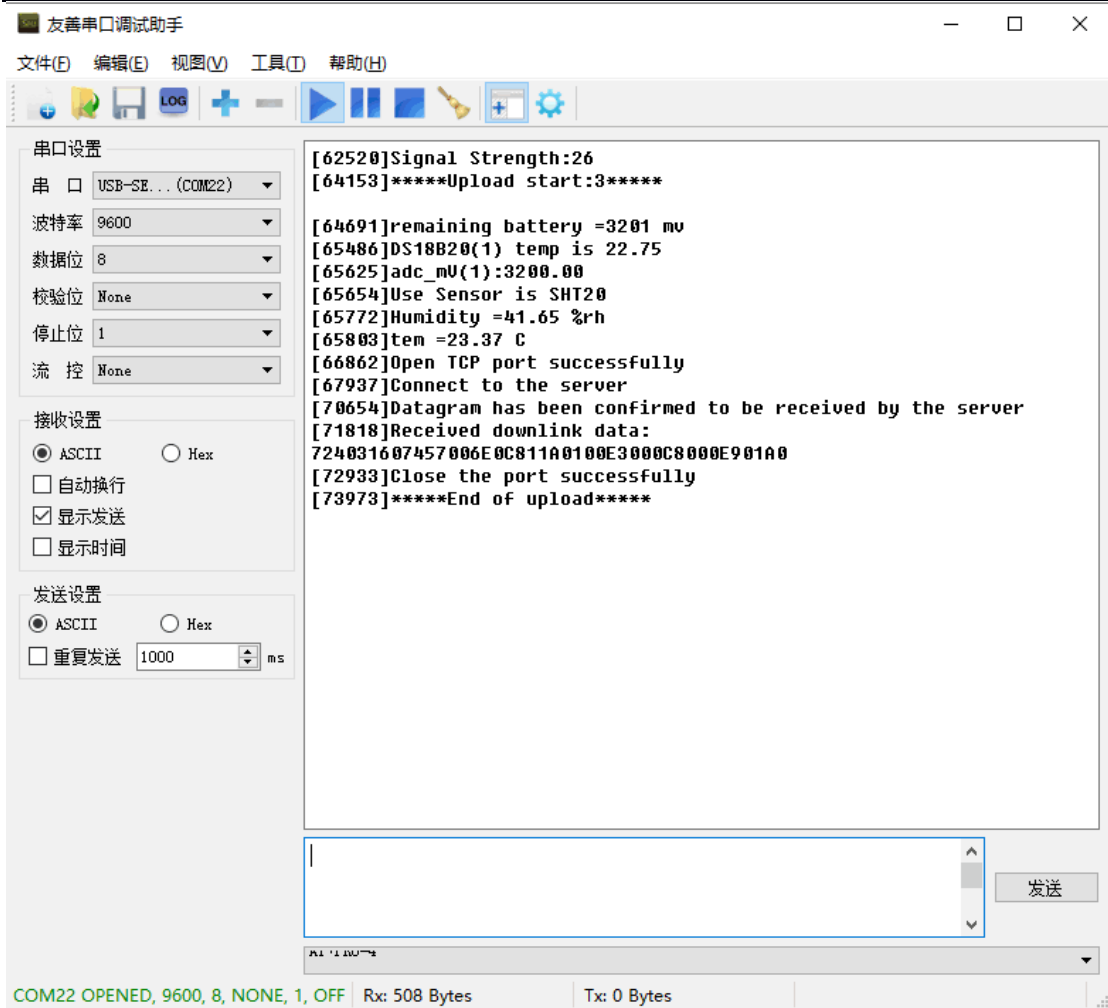

### 2.2.9 Change Update Interval

User can use below command to change the **uplink interval**.

```
AT+TDC=600 // Set Update Interval to 600s
```

## 2.3 Working Mode & Uplink Payload

NBSN95 has different working mode for the connections of different type of sensors. This section describes these modes. User can use the AT Command **AT+MOD** to set NBSN95 to different working modes.

For example:

**AT+CFGMOD=2** // will set the NBSN95 to work in [MOD=2 distance mode](#) which target to measure distance via Ultrasonic Sensor.

The uplink payloads are composed in ASCII String. For example:

`0a cd 00 ed 0a cc 00 00 ef 02 d2 1d` (total 24 ASCII Chars) . Representative the actually payload:

`0x 0a cd 00 ed 0a cc 00 00 ef 02 d2 1d` Total 12 bytes

**NOTE:**

1. All modes share the same Payload Explanation from [HERE](#).
2. By default, the device will send an uplink message every 1 hour.

### 2.3.1 CFGMOD=1 (Default Mode)

In this mode, uplink payload includes in total 21 bytes

Size (bytes)	6	2	2	1	1	2	1	2	2	2
Value	<a href="#">Device ID</a>	<a href="#">Ver</a>	<a href="#">BAT</a>	<a href="#">Signal Strength</a>	MOD 0x01	<a href="#">Temperature (DS18B20)</a>	<a href="#">Digital in &amp; Interrupt</a>	<a href="#">ADC</a>	<a href="#">Temperature by SHT20/SHT31</a>	<a href="#">Humidity by SHT20/SHT31</a>

If we use the MQTT client to subscribe to this MQTT topic, we can see the following information when the NB sensor uplink data.

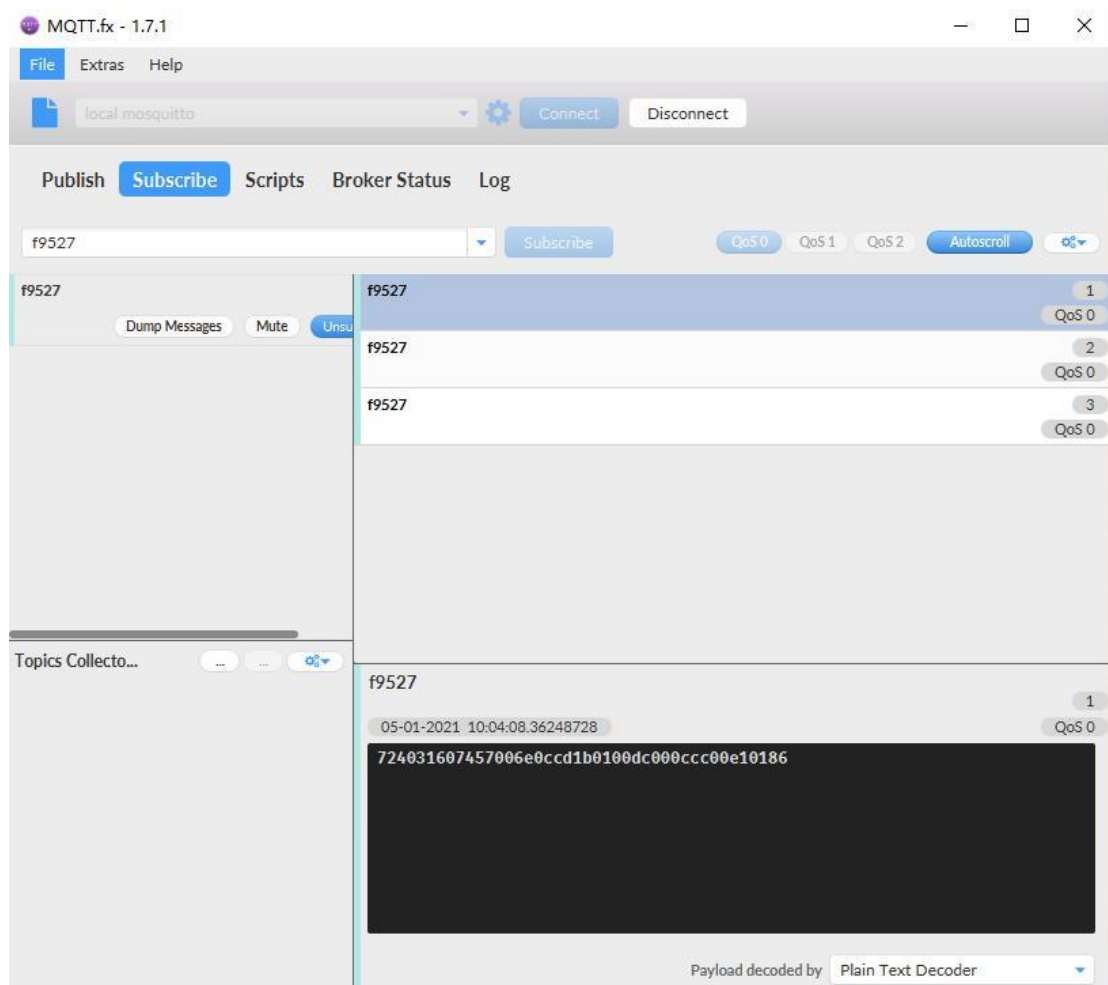

The payload is ASCII string, representative same HEX:

0x724031607457006e0ccd1b0100dc000ccc00e10186 where:

- Device ID: 0x724031607457 = 724031607457
- Version: 0x006e=110=1.1.0
- BAT: 0x0ccd = 3277 mV = 3.277V
- Signal: 0x1b = 27
- Model: 0x01 = 1
- Temperature by DS18b20: 0x00dc= 220 = 22.0 ° C
- Interrupt: 0x00 = 0
- ADC: 0x0ccc = 3276 = 3276mv

- Temperature by SHT20/SHT31:  $0x00e1 = 225 = 22.5 \text{ }^\circ \text{C}$
- Humidity by SHT20/SHT31:  $0x0186 = 390 = 39.0 \text{ \%rh}$

### 2.3.2 CFGMOD=2 (Distance Mode)

This mode is target to measure the distance. Total 19 bytes,

Size (bytes)	6	2	2	1	1	2	1	2	2
Value	<a href="#">Device ID</a>	<a href="#">Ver</a>	<a href="#">BAT</a>	<a href="#">Signal Strength</a>	MOD 0x02	<a href="#">Temperature (DS18B20)</a>	<a href="#">Digital in &amp; Interrupt</a>	<a href="#">ADC</a>	<a href="#">Distance measure</a> by: 1) <a href="#">LIDAR-Lite V3HP</a> Or 2) <a href="#">Ultrasonic Sensor</a>

If we use the MQTT client to subscribe to this MQTT topic, we can see the following information when the NB sensor uplink data.

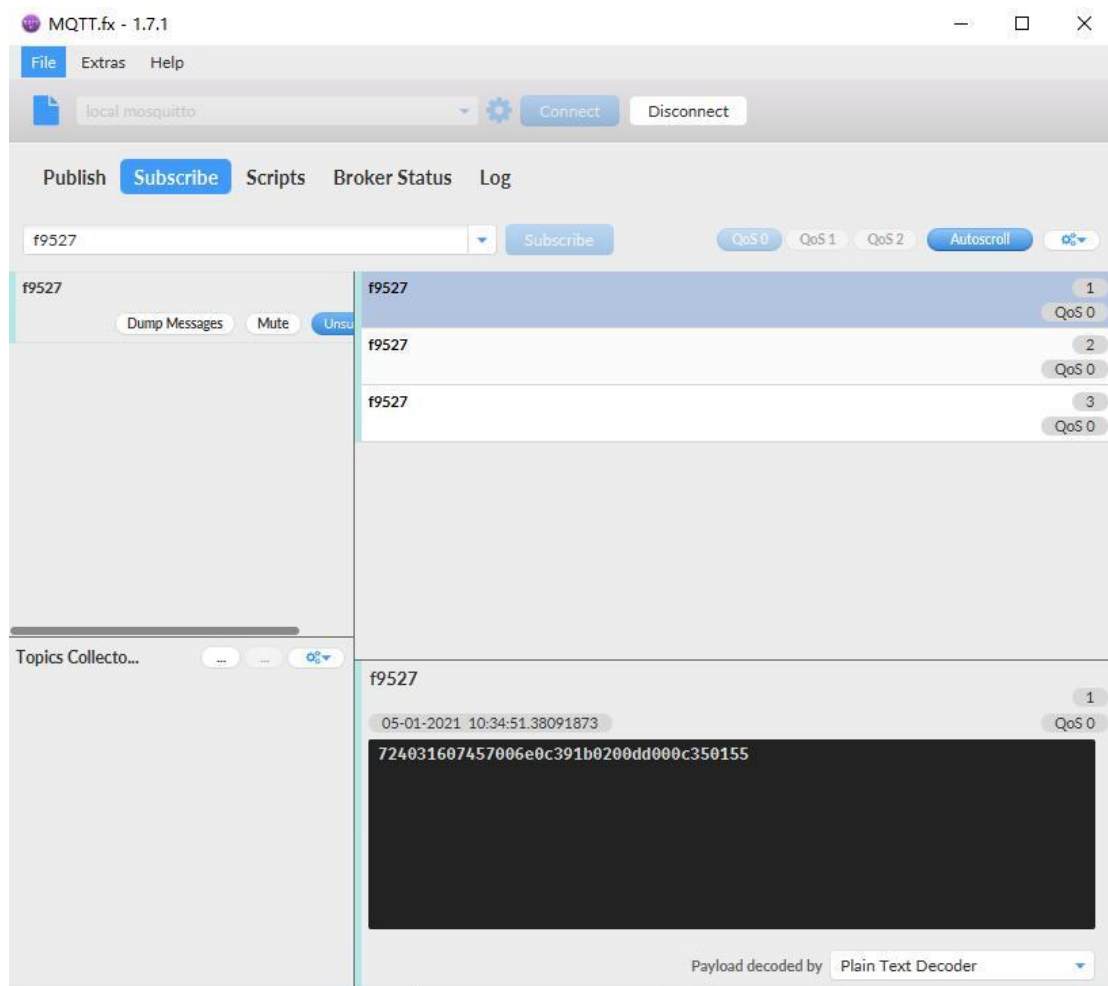

So the payload is  $0x724031607457006e0c391b0200dd000c350155$  where:

- Device ID:  $0x724031607457 = 724031607457$
- Version:  $0x006e=110=1.1.0$
- BAT:  $0x0c39 = 3129\text{mV} = 3.129 \text{ V}$
- Signal:  $0x1b = 27$
- Model:  $0x02 = 2$

- Temperature by DS18B20: 0x00dd= 221 = 22.1 ° C
- Interrupt: 0x00 = 0
- ADC: 0x0c35 = 3125 mv
- Distance by LIDAR-Lite V3HP/Ultrasonic Sensor: 0x0155 = 341 cm

Connection of LIDAR-Lite V3HP:



Connection to Ultrasonic Sensor:

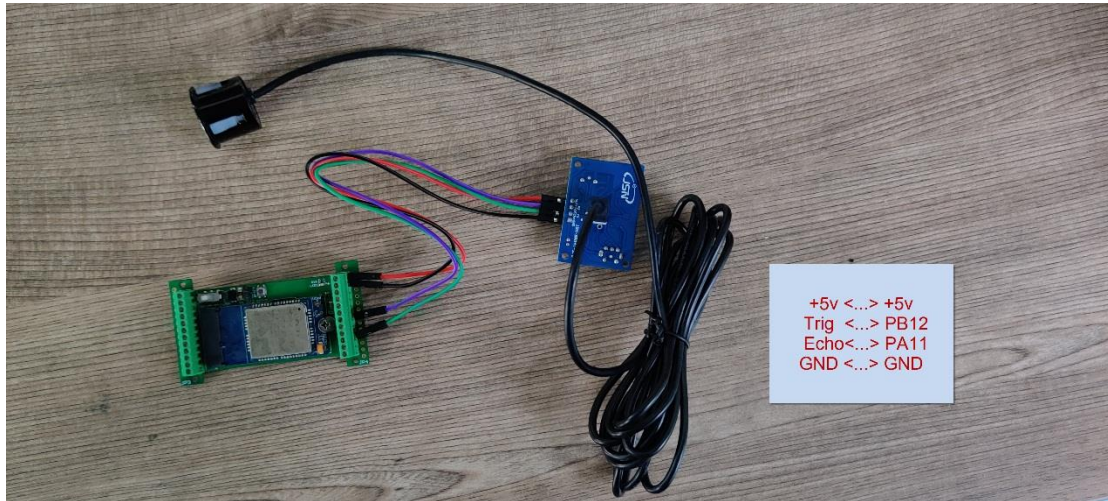

**2.3.3 CFGMOD=3 (3 ADC + I2C)**

This mode has total 24 bytes. Include 3 x ADC + 1x I2C

Size (bytes)	6	2	2	1	1	2	1	2	2	2	2
Value	<a href="#">Device ID</a>	<a href="#">Ver</a>	<a href="#">BAT</a>	<a href="#">Signal Strength</a>	MOD 0x03	<a href="#">ADC1</a>	<a href="#">Digital in &amp; Interrupt</a>	<a href="#">ADC2</a>	<a href="#">Temperature by SHT20/SHT31</a>	<a href="#">Humidity by SHT20/SHT31</a>	<a href="#">ADC3</a>

ADC1 uses pin PA0 to measure  
 ADC2 uses pin PA1 to measure



## ADC3 uses pin PA4 to measure

If we use the MQTT client to subscribe to this MQTT topic, we can see the following information when the NB sensor uplink data.

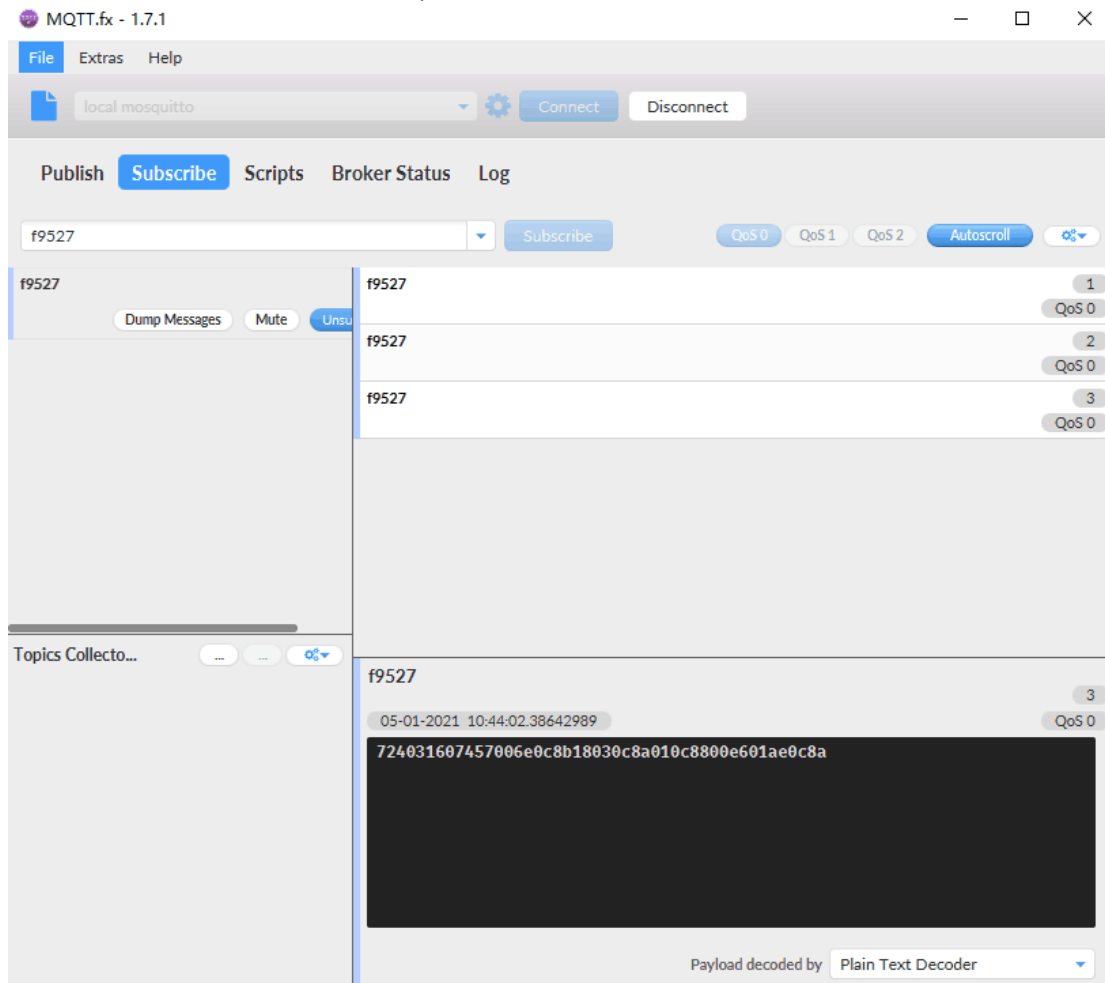

So the payload is 0x724031607457006e0c8b18030c8a010c8800e601ae0c8a where:

- Device ID: 0x724031607457 = 724031607457
- Version: 0x006e=110=1.1.0
- BAT: 0x0c8b = 3211 mV = 3.211 V
- Signal: 0x18 = 24
- Model: 0x03 = 3
- ADC1: 0x0c8a= 3210mV
- Interrupt: 0x01 = 1
- ADC2: 0x0c88 = 3208 mv
- Temperature by SHT20/SHT31: 0x00e6 = 230 = 23.0 ° C
- Humidity by SHT20/SHT31: 0x01ae =174 = 17.4 %rh
- ADC2: 0x0c8a = 3210 mv

### 2.3.4 CFGMOD=4 (3 x DS18B20)

Hardware connection is as below, (Note: R3 & R4 should change from 10k to 4.7k to support DS18B20, Software set to AT+CFGMOD=4)

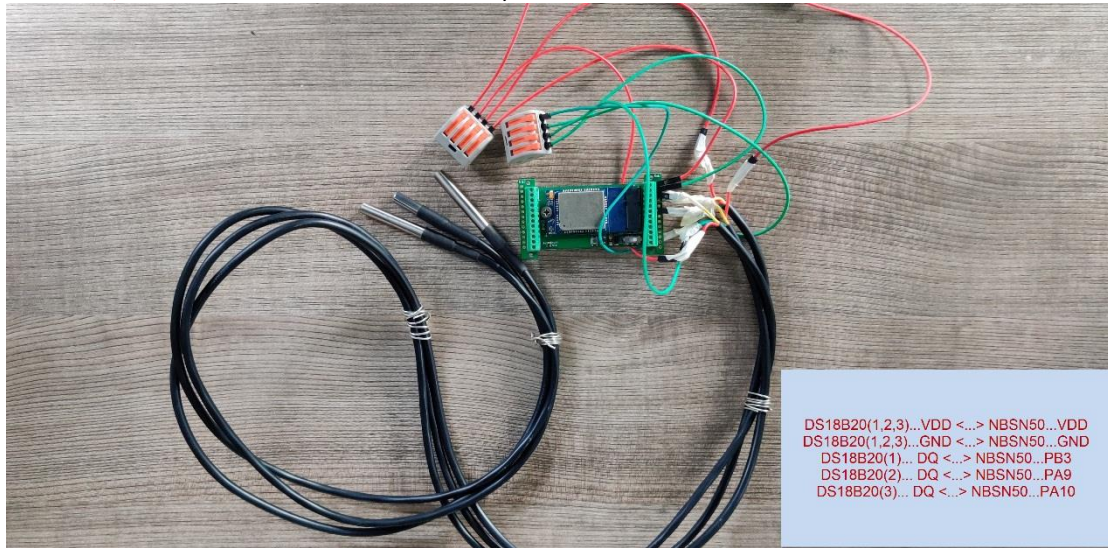

This mode has total 22 bytes. As shown below:

Size (bytes)	6	2	2	1	1	2	2	1	2	2
Value	<a href="#">Device ID</a>	<a href="#">Ver</a>	<a href="#">BA I</a>	<a href="#">Signal strength</a>	MOD (0x04 )	<a href="#">Temperature1 (DS18B20) (PB3)</a>	<a href="#">ADC</a>	<a href="#">Digital in &amp; Digital Interrupt</a>	<a href="#">Temperature2 (DS18B20) (PA9)</a>	<a href="#">Temperature3 (DS18B20) (PA10)</a>

If we use the MQTT client to subscribe to this MQTT topic, we can see the following information when the NB sensor uplink data.

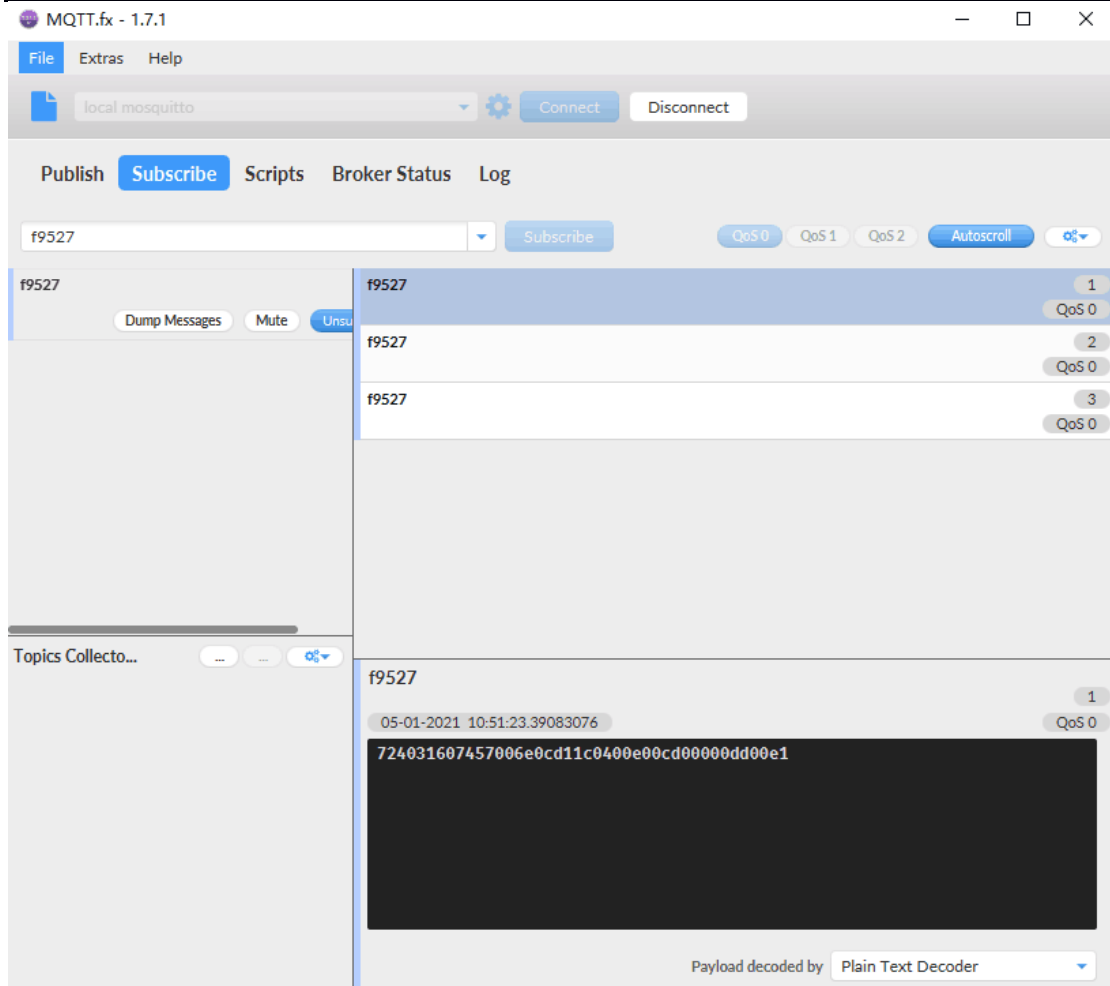

So the payload is 0x724031607457006e0cd11c0400e00cd00000dd00e1 where:

- Device ID: 0x724031607457 = 724031607457
- Version: 0x006e=110=1.1.0
- BAT: 0x0cd1 = 3281 mV = 3.281 V
- Singal: 0x1c = 28
- Model: 0x04 = 4
- Temperature by DS18b20: 0x00e0 = 224 = 22.4 ° C
- ADC: 0x0cd0 = 3280 mv
- Interrupt: 0x00 = 0
- Temperature by DS18b20: 0x00dd = 221 = 22.1 ° C
- Temperature by DS18b20: 0x00e1 = 225 = 22.5 ° C

### 2.3.5 CFGMOD=5(Weight Measurement by HX711)

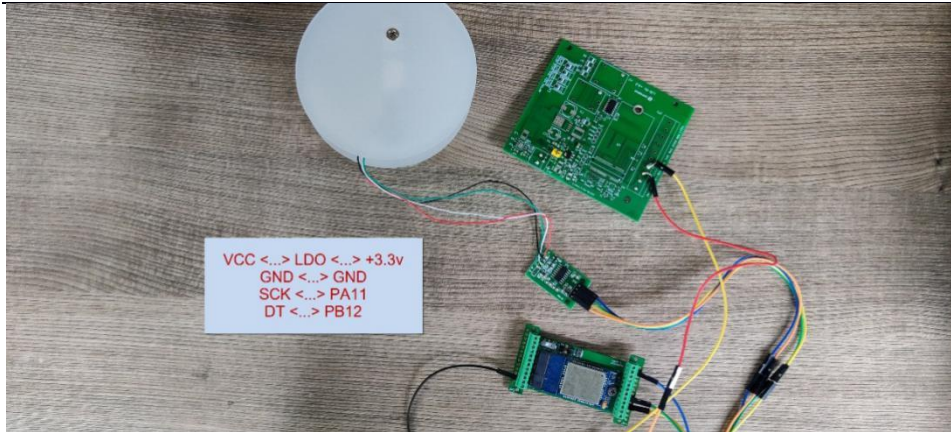

Notes about hardware connection:

- 1) Don't connect the HX711 module VCC to NBSN95 3.3v VCC, in this case, the NBSN95 will always power on HX711 and the battery will run out soon.
- 2) HX711 support 5v VCC, but while connect the NBSN95's +5V to HX711 VCC, the value from HX711 is not stable.
- 3) Connect NBSN95 +5V to HX711 VCC via a LDO module is stable.

Each HX711 need to be calibrated before used. User need to do below two steps:

- a) Zero calibration. Don't put anything on load cell and run **AT+WEIGRE** to calibrate to Zero gram.
- b) Adjust calibration factor (default value 400): Put a known weight thing on load cell and run **AT+WEIGAP** to adjust the Calibration Factor.  
For example:

**AT+WEIGAP =403.0**

Response: Weight is 401 g

Check the response of this command and adjust the value to match the real value for thing.

This mode has total 20 bytes. As shown below:

Size (bytes)	6	2	2	1	1	2	2	1	2
Value	<a href="#">Device ID</a>	<a href="#">Ver</a>	<a href="#">BAT</a>	<a href="#">Signal strength</a>	MOD (0x05)	<a href="#">Temperature (DS18B20)</a>	<a href="#">ADC</a>	<a href="#">Digital in &amp; Digital Interrupt</a>	<a href="#">Weight</a>

If we use the MQTT client to subscribe to this MQTT topic, we can see the following information when the NB sensor uplink data.

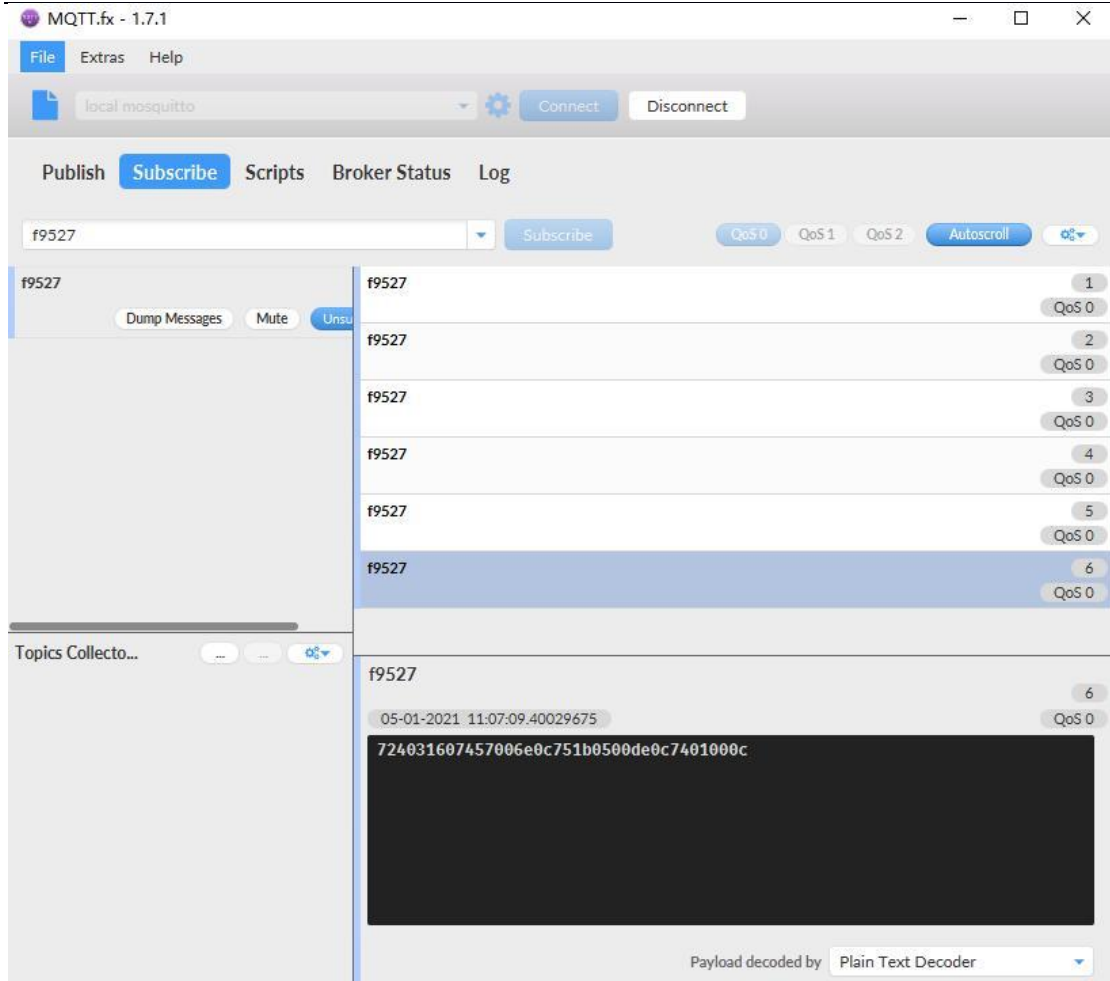

So the payload is 0x724031607457006e0c751b0500de0c740100c where:

- Device ID: 0x724031607457 = 724031607457
- Version: 0x006e=110=1.1.0
- BAT: 0x0c75 = 3189 mV = 3.189 V
- Singal: 0x1b = 27
- Model: 0x05 = 5
- Temperature by DS18b20: 0x00de = 222 = 22.2 ° C
- ADC: 0x0c74 = 3188 mv
- Interrupt: 0x01 = 1
- Weigt by HX711: 0x000c = 12 g

### 2.3.6 CFGMOD=6(Counting mode)

Size (bytes)	6	2	2	1	1	2	4
Value	<a href="#">Device ID</a>	<a href="#">Ver</a>	<a href="#">BAT</a>	<a href="#">Signal Strength</a>	MOD 0x06	Pulse coefficient	Pulse count

In this mode, uplink payload includes in total 18 bytes

The pulse count uses [Digital Input](#) pin to measure pulse.

The Pulse coefficient is a FLAG to tell the IoT server what value it should consider for each pulse, pulse coefficient won't affect the value of pulse count. For example, if user connects to a water meter which will generate a pulse for 1.5L. User can use command "AT+CNTFAC=1.5" for configuration. Users can use the command "AT+CNTFAC" to set according to the actual situation.

If we use the MQTT client to subscribe to this MQTT topic, we can see the following information when the NB sensor uplink data.

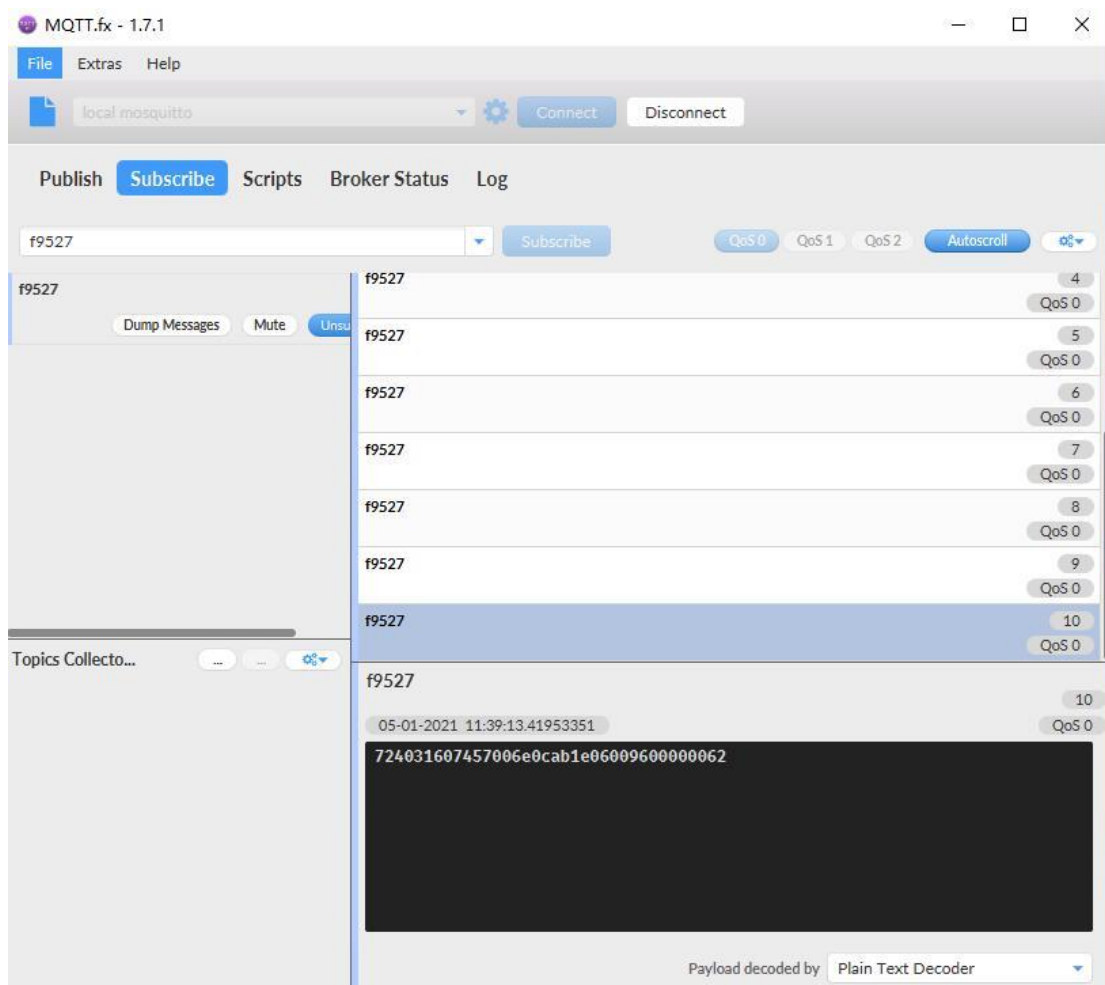

The payload is ASCII string, representative same HEX:  
0x724031607457006e0cab1e06009600000062 where:

- Device ID: 0x724031607457 = 724031607457
- Version: 0x006e=110=1.1.0
- BAT: 0x0cab = 3243mV = 3.243V
- Signal: 0x1a = 26
- Model: 0x06 = 6
- Pulse coefficient: 0x0096=150=1.5(L/pulse)
- Pulse count: 0x00000062= 98

So, the actual flow is:  $1.5 * 98 = 147(L)$

## 2.4 Payload Explanation and Sensor Interface

### 2.4.1 Device ID

By default, the Device ID equal to the last 6 bytes of IMEI.

User can use AT+DEUI to set Device ID

Example:

```
AT+DEUI=A84041F15612
```

The Device ID is stored in a none-erase area, Upgrade the firmware or run AT+FDR won't erase Device ID.

### 2.4.2 Version Info

These bytes include the hardware and software version.

Higher byte: Specify hardware version: always 0x00 for NBSN95

Lower byte: Specify the software version: 0x6E=110, means firmware version 110

For example: 0x00 6E: this device is NBSN95 with firmware version 110.

### 2.4.3 Battery Info

Ex1: 0x0B45 = 2885mV

Ex2: 0x0B49 = 2889mV

### 2.4.4 Signal Strength

NB-IoT Network signal Strength.

Ex1: 0x1d = 29

**0** -113dBm or less

**1** -111dBm

**2...30** -109dBm... -53dBm

**31** -51dBm or greater

**99** Not known or not detectable

### 2.4.5 Temperature (DS18B20)

If there is a DS18B20 connected to PB3 pin. The temperature will be uploaded in the payload.

More DS18B20 can check the [3 DS18B20 mode](#)

#### Connection for one DS18B20

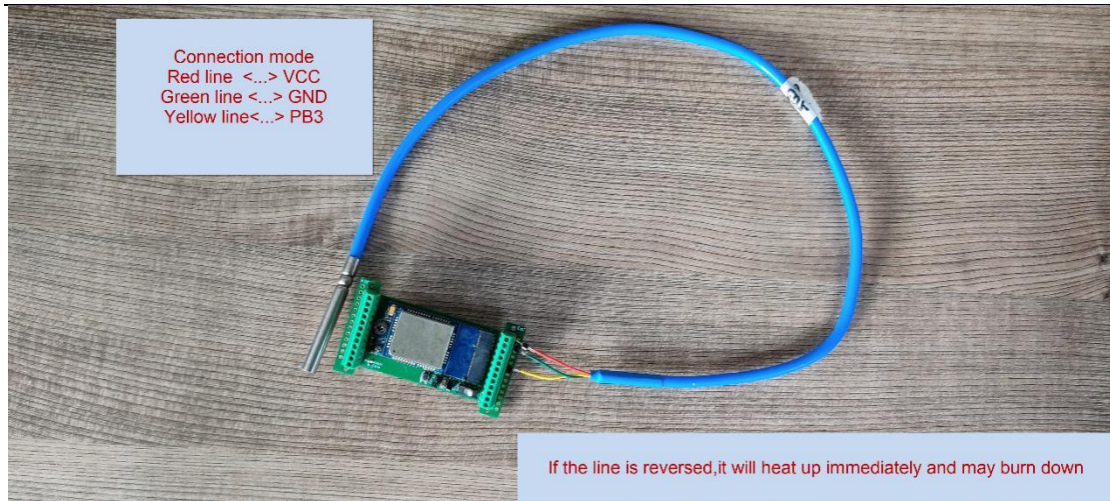

**Example:**

If payload is: 0x0105: (0105 & FC00 == 0), temp = 0x0105 /10 = 26.1 degree

If payload is: 0xFF3F: (FF3F & FC00 == 1) , temp = (0xFF3F - 65536)/10 = -19.3 degree.

#### 2.4.6 Digital Input

The digital input is for pin PA12,

- When PA12 is high, the bit2 of this byte is 1.
- When PA12 is low, the bit2 of this byte is 0.

#### 2.4.7 Analogue Digital Converter (ADC)

The ADC monitors the voltage on the **PA0** line, in mV. Max value is from 0v to BAT voltage

Ex: 0x021F = 543mv,

**Example1:** Reading a Liquid Level Sensor (Read a resistance value):



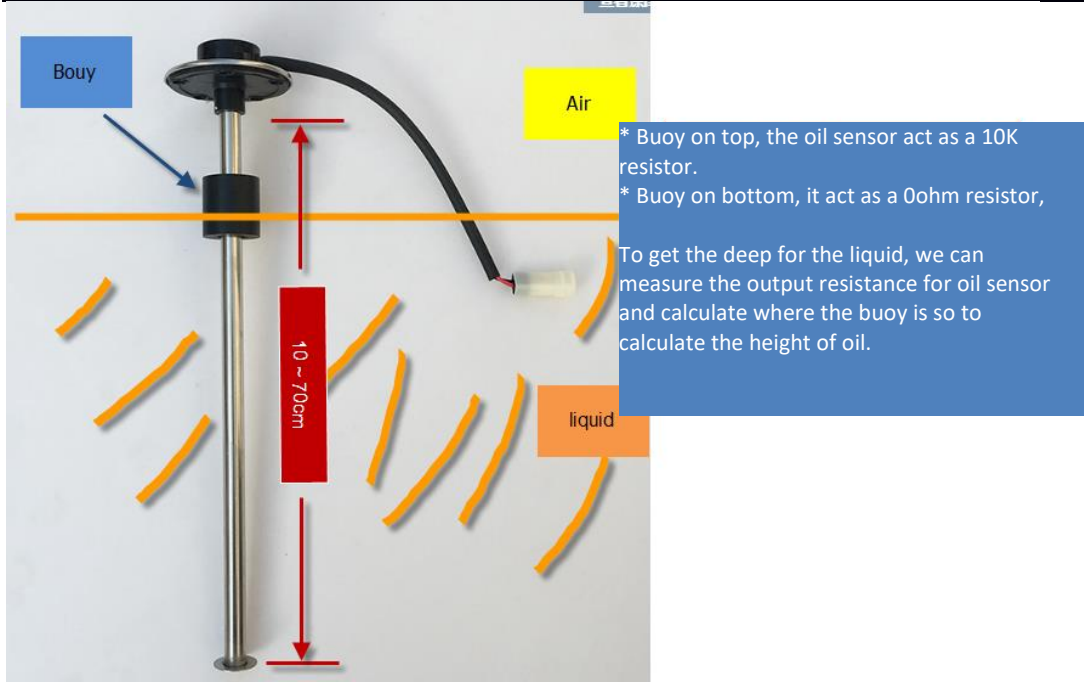

In the NBSN95, we can use PB4 and PA0 pin to calculate the resistance for the liquid level sensor. The bottom of this sensor equal to 0ohm and top position equals to 10kohm.

Steps:

1. Solder a 10K resistor between PA0 and VCC.
2. Screw liquid level sensor's two pins to PA0 and PB4.

The equipment circuit is as below:

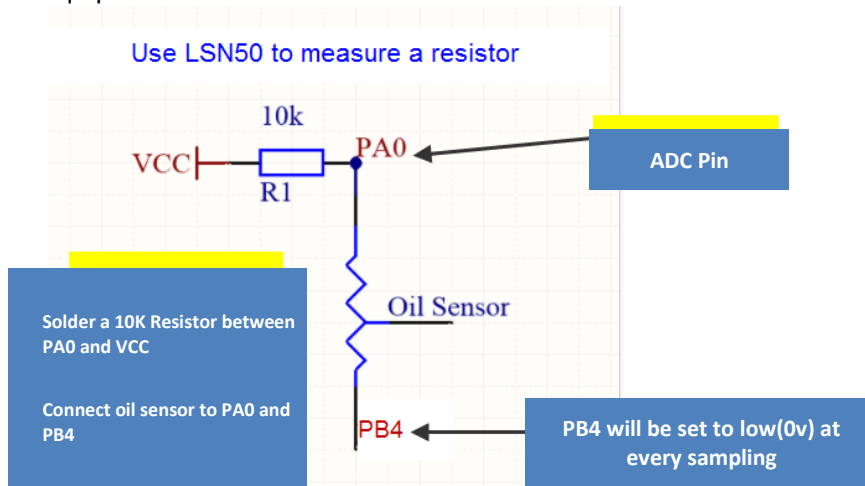

According to above diagram:

$$(VCC - V_{PA0}) \frac{10}{k} = \frac{V_{PA0}}{R_{oil\ sensor}}$$

So

$$R_{oil\ sensor} = V_{PA0} \times 10 \frac{K}{(VCC - V_{PA0})}$$

$V_{PA0}$  is the reading of ADC. So if ADC=0x05DC=0.9 v and VCC (BAT) is 2.9v

The  $R_{oil\_sensor} = 0.9 \times \frac{10K}{2.9-0.9} = 4.5K \text{ ohm}$

Since the buoy is linear resistance from 10 ~ 70cm.

The position of buoy is  $\frac{4.5K}{10K} \times (70cm - 10cm) + 10cm = 37cm$ , from the bottom of buoy

### 2.4.8 Digital Interrupt

Digital Interrupt refers to pin PB14, and there are different trigger methods. When there is a trigger, the NBSN95 will send a packet to the server.

#### Example to use with door sensor

The door sensor is shown at right. It is a two wire magnetic contact switch used for detecting the open/close status of doors or windows.

When the two pieces are close to each other, the 2 wire output will be short or open (depending on the type), while if the two pieces are away from each other, the 2 wire output will be the opposite status. So we can use NBSN95 interrupt interface to detect the status for the door or window.

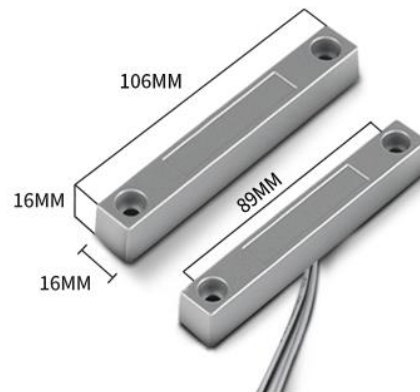

Below is the installation example:

Fix one piece of the magnetic sensor to the door and connect the two pins to NBSN95 as follows:

- One pin to NBSN95's PB14 pin
- The other pin to NBSN95's VCC pin

Install the other piece to the door. Find a place where the two pieces will be close to each other when the door is closed. For this particular magnetic sensor, when the door is closed, the output will be short, and PB14 will be at the VCC voltage.

Door sensors have two types: **NC (Normal close)** and **NO (Normal Open)**. The connection for both type sensors are the same. But the decoding for payload is reverse, user need to modify this in the IoT Server decoder.

When door sensor is shorted, there will extra power consumption in the circuit, the extra current is  $3v3/R14 = 3v2/1Mohm = 0.3\mu A$  which can be ignored.

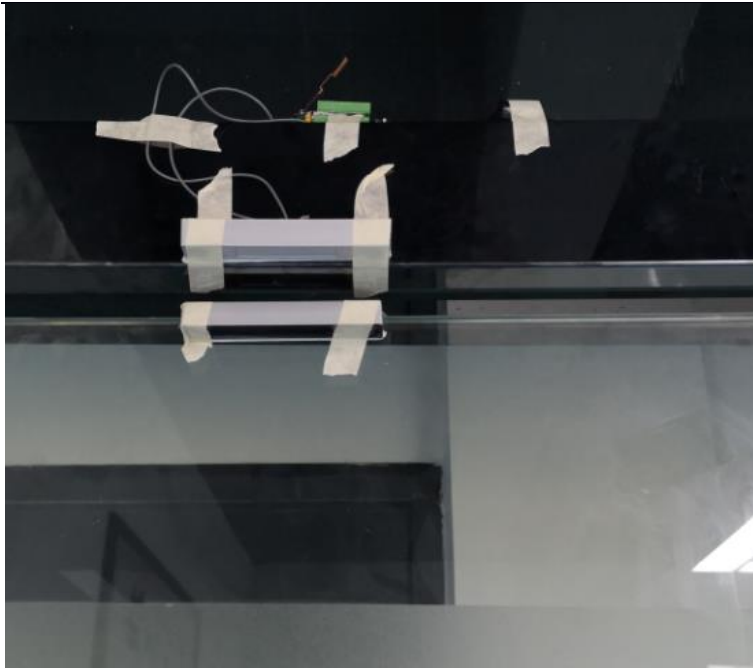

The above photos shows the two parts of the magnetic switch fitted to a door.

The software by default uses the falling edge on the signal line as an interrupt. We need to modify it to accept both the rising edge (0v --> VCC , door close) and the falling edge (VCC --> 0v , door open) as the interrupt.

The command is:

**AT+INTMOD=1** //(more info about INMOD please refer [AT Command Manual](#)).

Below shows some screen captures in TTN:

In MOD=1, user can use the **Digital Input & Interrupt** byte to see the status for door open or close. The Decode is:

- When PB14 is high, the bit8 of this byte is 1.
- When PB14 is low, the bit8 of this byte is 0.

#### 2.4.9 I2C Interface (SHT20)

The **PB6(SDA)** and **PB7(SCK)** are I2C interface. User can use these pins to connect to an I2C device and get the sensor data.

There is an example to show how to use the I2C interface to connect to the SHT20 Temperature and Humidity Sensor. This is support in **AT+CFGMOD=1** (default value).

Hardware connection for SHT20 is as below:

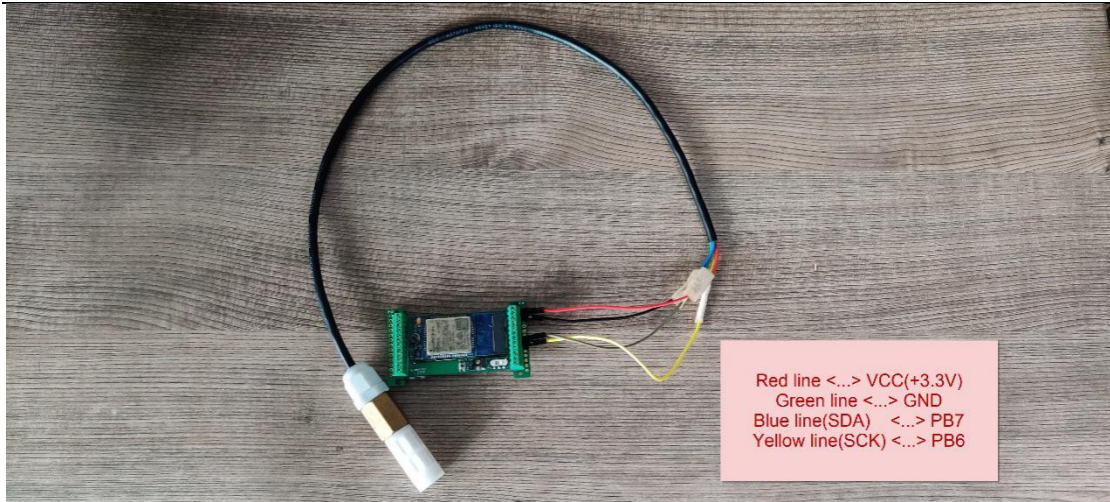

The device will be able to get the I2C sensor data now and upload to IoT Server.

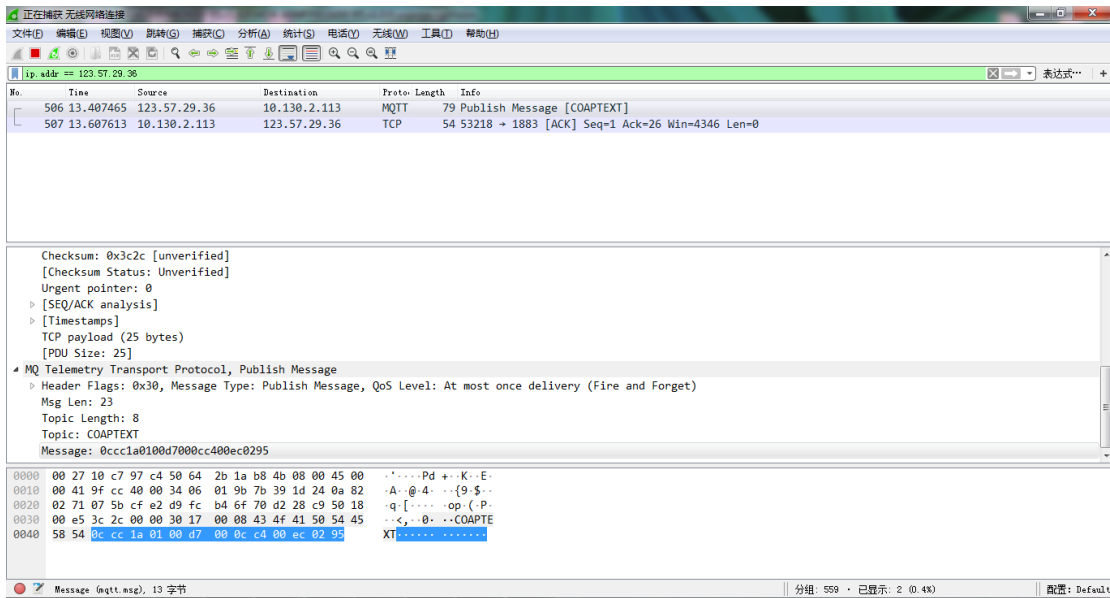

Convert the read byte to decimal and divide it by ten.

**Example:**

Temperature: Read:00ec (H) = 236(D) Value: 236 /10=23.6°C  
 Humidity: Read:0295(H)=661(D) Value: 661 / 10=66.1, So 66.1%

If you want to use other I2C device, please refer the SHT20 part source code as reference.

**2.4.10 Distance Reading**

Refer [Ultrasonic Sensor section](#).

**2.4.11 Ultrasonic Sensor**

The NBSN95 firmware supports ultrasonic sensor (with AT+CFGMOD=2) such as SEN0208 from DF-Robot. This Fundamental Principles of this sensor can be found at this link:

[https://wiki.dfrobot.com/Weather - proof Ultrasonic Sensor with Separate Probe SKU SEN0208](https://wiki.dfrobot.com/Weather_-_proof_Ultrasonic_Sensor_with_Separate_Probe_SKU_SEN0208)

The NBSN95 detects the pulse width of the sensor and converts it to mm output. The accuracy will be within 1 centimeter. The usable range (the distance between the ultrasonic probe and the measured object) is between 24cm and 600cm.

The picture below shows the connection:

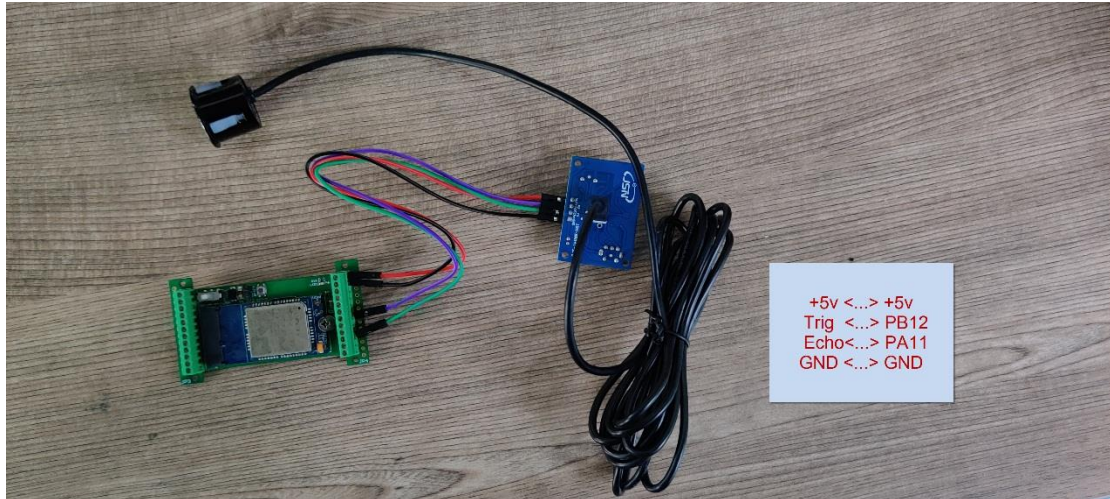

Connect to the NBSN95 and run `AT+CFGMOD=2` to switch to ultrasonic mode (ULT).

**Example:**

Distance: Read:0155(Hex) = 3410(D) Value: 3410 mm=341.0 cm

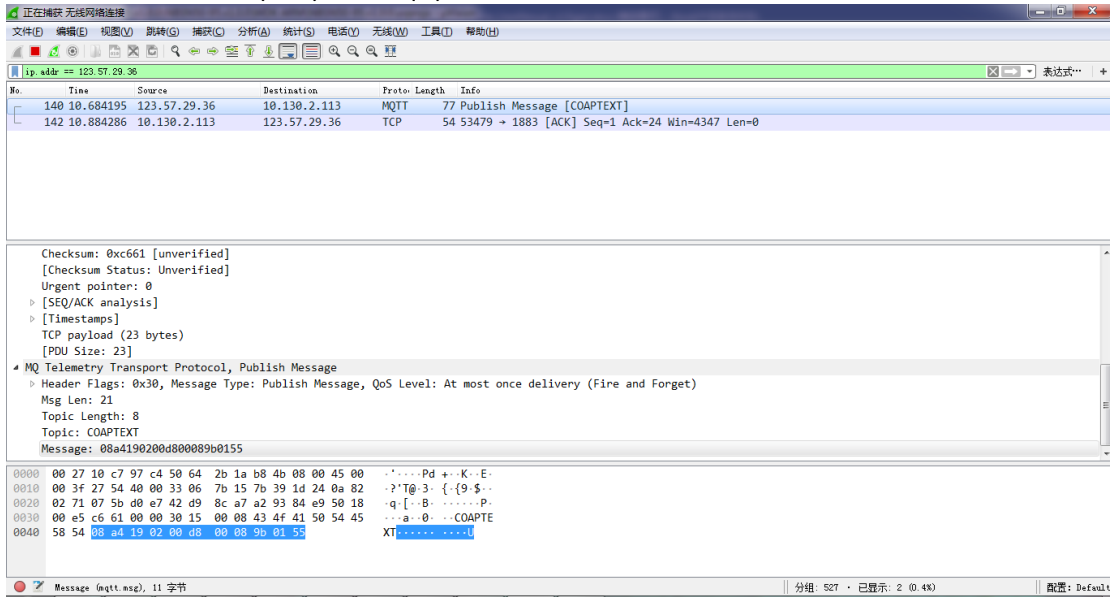

You can see the serial output in ULT mode as below:

---

```
[20-03-28 09:59:49]*****Upload start:2*****  
  
[20-03-28 09:59:49]remaining battery =2147 mV  
[20-03-28 09:59:49]DS18B20(1) temp is 26.25 ° C  
[20-03-28 09:59:50]adc_mV(1):2146.00  
  
[20-03-28 09:59:50]Distance =338cm  
[20-03-28 09:59:50]NB-IoT Signal Strength  
[20-03-28 09:59:50]Protocol in Used: Coap  
[20-03-28 09:59:50]Signal Strength:24  
  
[20-03-28 09:59:50]Waiting to send get-data.  
[20-03-28 09:59:52]Get-Data downlink successfully.  
[20-03-28 09:59:52]Waiting to send put-data.  
[20-03-28 09:59:55]Put-Data uploaded successfully.  
[20-03-28 09:59:55]*****End of upload*****  
  
[20-03-28 09:59:55]Enter low power mode
```

---

#### 2.4.12 +5V Output

NBSN95 will enable +5V output before all sampling and disable the +5v after all sampling.

The 5V output time can be controlled by AT Command.

**AT+5VT=1000**

Means set 5V valid time to have 1000ms. So the real 5V output will actually have 1000ms + sampling time for other sensors.

#### 2.4.13 Weigh Sensor HX711

NBSN95 supports Weigh Sensor HX711. See [this link](#) for instruction.

## 2.5 Downlink Payload

By default, NBSN95 prints the downlink payload to console port.

Downlink Control Type	FPort	Type Code	Downlink payload size(bytes)
TDC (Transmit Time Interval)	Any	01	4
RESET	Any	04	2
INTMOD	Any	06	4

### Examples

#### Set TDC

If the payload=0100003C, it means set the END Node's TDC to 0x00003C=60(S), while type code is 01.

Payload: 01 00 00 1E TDC=30S

Payload: 01 00 00 3C TDC=60S

#### Reset

If payload = 0x04FF, it will reset the NBSN95

#### INTMOD

Downlink Payload: 06000003, Set AT+INTMOD=3

## 2.6 Firmware Change Log

Download URL & Firmware Change log

[www.dragino.com/downloads/index.php?dir=NB-IoT/NBSN95/Firmware/](http://www.dragino.com/downloads/index.php?dir=NB-IoT/NBSN95/Firmware/)

Upgrade Instruction: [Upgrade Firmware](#)

## 2.7 Use VDD or +5V to Power External Sensor

User can use VDD or +5V to power external sensor. Note:

- 1) VDD is 2.5~3.3v from the battery + diode, the VDD is always on, so when use VDD to power external sensor, make sure the sensor has a low power consumption in sleep mode ( less 50 uA) to get a long battery life.
- 2) +5V output is only ON when sampling. And MCU will turn off it after sampling. So if sensor can support 5v, +5V out is the best choice. [See here for more info.](#)

Note: Always test the actually current pass by the JP2 jumper when connect to a new type of sensor.

## 2.8 Battery Analysis

### 2.8.1 Battery Type

The NBSN95 battery is a combination of an 8500mAh Li/SOCI2 Battery and a Super Capacitor. The battery is none-rechargeable battery type with a low discharge rate (<2% per year). This type of battery is commonly used in IoT devices such as water meter.

The battery is designed to last for several years depends on the actually use environment and update interval.

The battery related documents as below:

- [Battery Dimension](#),
- [Lithium-Thionyl Chloride Battery datasheet](#)
- [Lithium-ion Battery-Capacitor datasheet](#),





## 2.8.2 Power consumption Analyze

The file [DRAGINO NBSN95-Power-Analyzer.pdf](#) from <http://www.dragino.com/downloads/index.php?dir=NB-IoT/NBSN95/> describes a detail measurement to analyze the power consumption in different case. User can use it for design guideline for their project.

## 2.8.3 Battery Note

The Li-SICO battery is designed for small current / long period application. It is not good to use a high current, short period transmit method. The recommended minimum period for use of this battery is 5 minutes. If you use a shorter period time to uplink data, then the battery life may be decreased.

## 2.8.4 Replace the battery

You can change the battery in the NBSN95. The type of battery is not limited as long as the output is between 3v to 3.6v. On the main board, there is a diode (D1) between the battery and the main circuit. If you need to use a battery with less than 3.3v, please remove the D1 and shortcut the two pads of it so there won't be voltage drop between battery and main board.

The default battery pack of NBSN95 includes a ER26500 plus super capacitor. If user can't find this pack locally, they can find ER26500 or equivalence without the SPC1520 capacitor, which will also work in most case. The SPC can enlarge the battery life for high frequency use (update period below 5 minutes)

## 3. Access NB-IoT Module

Users can directly access the AT command set of the NB-IoT module.

The AT Command set can refer the BC95-G AT Command:

<http://www.dragino.com/downloads/index.php?dir=NB-IoT/BC95-G/>

The AT Command set can refer the BC35-G AT Command:

[https://www.dragino.com/downloads/index.php?dir=datasheet/other\\_vendors/BC35-G/](https://www.dragino.com/downloads/index.php?dir=datasheet/other_vendors/BC35-G/)

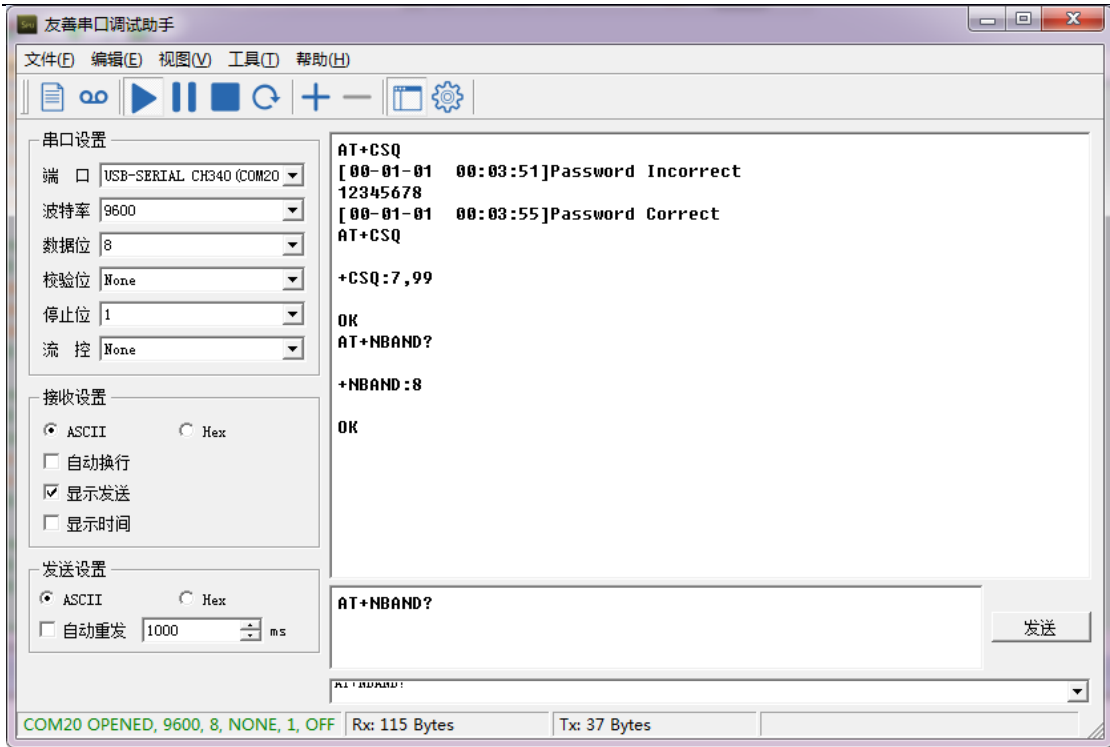

## 4. Using the AT Commands

### 4.1 Access AT Commands

See this link for detail:

<http://www.dragino.com/downloads/index.php?dir=NB-IoT/NBSN95/>

AT+<CMD>? : Help on <CMD>  
AT+<CMD> : Run <CMD>  
AT+<CMD>=<value> : Set the value  
AT+<CMD>=? : Get the value

#### General Commands

AT : Attention  
AT? : Short Help  
ATZ : MCU Reset  
AT+TDC : Application Data Transmission Interval  
AT+CFG : Print all configurations  
AT+CFGMOD : Working mode selection  
AT+INTMOD : Set the trigger interrupt mode  
AT+5VT : Set extend the time of 5V power  
AT+PRO : Choose agreement  
AT+WEIGRE : Get weight or set weight to 0  
AT+WEIGAP : Get or Set the GapValue of weight  
AT+RXDL : Extend the sending and receiving time  
AT+CNTFAC : Get or set counting parameters  
AT+SERVADDR : Server Address

#### COAP Management

AT+URI : Resource parameters

#### UDP Management

AT+CFM : Upload confirmation mode (only valid for UDP)

#### MQTT Management

AT+CLIENT : Get or Set MQTT client  
AT+UNAME : Get or Set MQTT Username  
AT+PWD : Get or Set MQTT password  
AT+PUBTOPIC : Get or Set MQTT publish topic  
AT+SUBTOPIC : Get or Set MQTT subscription topic

#### Information

AT+FDR : Factory Data Reset  
AT+PASSWORD : Serial Access Password

## 5. Developer Guide

### 5.1 Get and compile Software

NBSN95 is an open-source project, developer can compile their firmware for customized applications. User can get the source code from:

- Software Source Code: <https://github.com/dragino/NBSN95>
- Compile instruction: [http://wiki.dragino.com/index.php?title=Firmware\\_Compile\\_Instruction\\_--\\_STM32](http://wiki.dragino.com/index.php?title=Firmware_Compile_Instruction_--_STM32)
- Upgrade firmware instruction  
See FAQ of this file.

The project file is in:

[NBSN95-95.v1.0.0\NBSN95-95.v1.0.0\MDK-ARM\NBSN95-95.v1.0.0.uvprojx](#)

### 5.2 Get hardware source

NBSN95 are the compose of two PCB modules:

- 1) Mother board: [LoRa ST Sensor node mother board](#).
- 2) NB-IoT Module: <https://github.com/dragino/NB-IoT/tree/master/NB%20ST/BC95>

## 6. FAQ

### 6.1 How to Upgrade Firmware

User can upgrade the firmware for 1) bug fix, 2) new feature release.

Please see this link for how to upgrade:

[http://wiki.dragino.com/index.php?title=Firmware Upgrade Instruction for STM32 base products#Hardware Upgrade Method Support List](http://wiki.dragino.com/index.php?title=Firmware_Upgrade_Instruction_for_STM32_base_products#Hardware_Upgrade_Method_Support_List)

Notice, NBSN50 and LSN50v2 share the same mother board. They use the same connection and method to update.

## 7. Trouble Shooting

### 7.1 Connection problem when uploading firmware.

Please see:

[http://wiki.dragino.com/index.php?title=Firmware\\_Upgrade\\_Trouble\\_Shooting#UART\\_upgrade\\_trouble\\_shooting](http://wiki.dragino.com/index.php?title=Firmware_Upgrade_Trouble_Shooting#UART_upgrade_trouble_shooting)

### 7.2 AT Command input doesn't work

In the case if user can see the console output but can't type input to the device. Please check if you already include the **ENTER** while sending out the command. Some serial tool doesn't send **ENTER** while press the send key. In this case, user need to add ENTER in the string to send, as below:

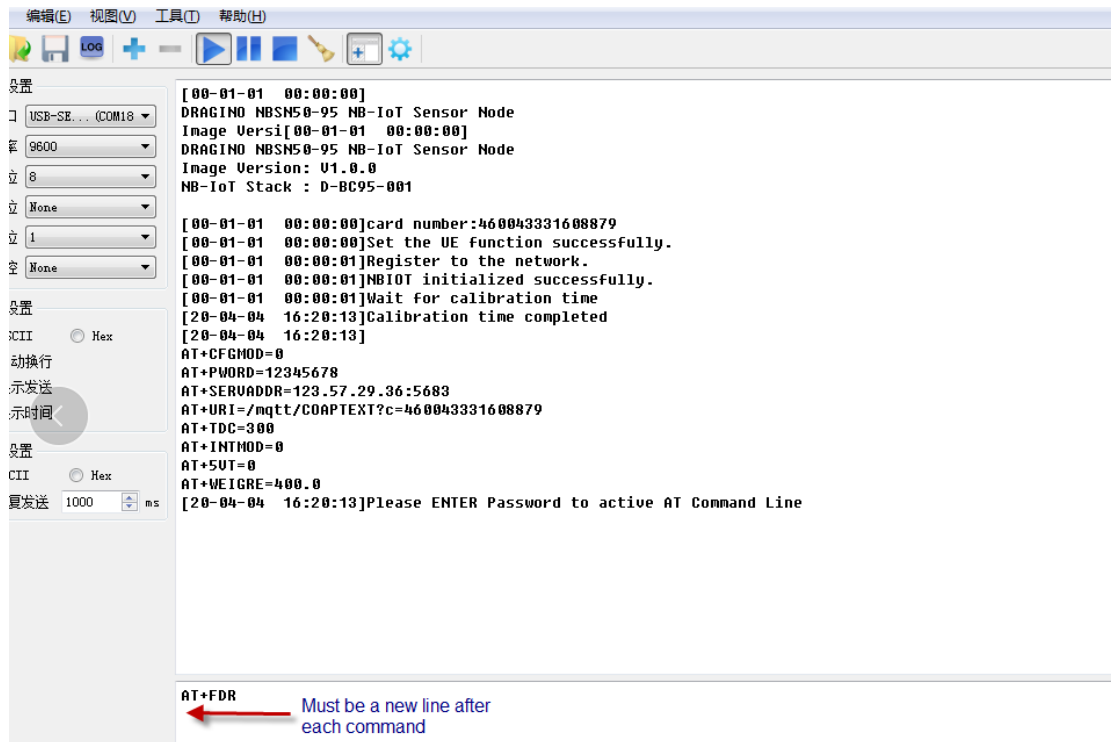

## 8. Order Info

Part Number:

**NBSN95-YY (Base on BC95-G)**

or

**NBSN95A-YY(Base on BC35-G)**

**YY:**

- **12:** With M12 waterproof cable hole
- **16:** With M16 waterproof cable hole
- **NH:** No Hole

## 9. Packing Info

### **Package Includes:**

- NBSN95 NB-IoT Sensor Node x 1
- External antenna x 1

### **Dimension and weight:**

- Device Size: 13.0 x 5 x 4.5 cm
- Device Weight: 150g
- Package Size / pcs : 14.0 x 8x 5 cm
- Weight / pcs : 180g

## 10. Support

- Support is provided Monday to Friday, from 09:00 to 18:00 GMT+8. Due to different timezones we cannot offer live support. However, your questions will be answered as soon as possible in the before-mentioned schedule.
- Provide as much information as possible regarding your enquiry (product models, accurately describe your problem and steps to replicate it etc) and send a mail to

[support@dragino.com](mailto:support@dragino.com)