



## LIG16 LoRaWAN Gateway User Manual

---

Document Version: 1.1

Firmware Version: lgw--build-v5.4.1615882321-20210316-1613/

Version	Description	Date
1.0	Release	2021-Jan-3
1.1	Add AWS-IoT support	2021-Mar-27
1.2	Change LoRaWAN Server to use TTNv3	2022-Jan-19

<b>1. Introduction.....</b>	<b>5</b>
1.1 <i>What is LIG16 Indoor LoRaWAN Gateway .....</i>	5
1.2 <i>Specifications.....</i>	7
1.3 <i>Features.....</i>	8
1.4 <i>Hardware System Structure.....</i>	8
1.5 <i>LIG16 Applications.....</i>	8
1.6 <i>LED Indicators.....</i>	9
<b>2. Access and configure LIG16.....</b>	<b>10</b>
2.1 <i>Find IP address of LIG16 .....</i>	10
2.1.1 <i>Connect via WiFi .....</i>	10
2.1.2 <i>Connect via WAN port with DHCP IP from router.....</i>	10
2.1.3 <i>Connect via WiFi with DHCP IP from router .....</i>	11
2.1.4 <i>Connect via WAN port by fall back ip .....</i>	11
2.2 <i>Access Configure Web UI.....</i>	12
<b>3. Typical Network Setup .....</b>	<b>13</b>
3.1 <i>Overview .....</i>	13
3.2 <i>Use WAN port to access Internet.....</i>	13
3.3 <i>Access Internet as a WiFi Client.....</i>	14
3.4 <i>Check Internet connection.....</i>	15
<b>4. Example : Configure as a LoRaWAN gateway.....</b>	<b>16</b>
4.1 <i>Create a gateway in TTN v3 Server .....</i>	17
4.2 <i>Configure LIG16 to connect to TTN v3.....</i>	20
4.3 <i>Configure frequency.....</i>	22
4.4 <i>Add a LoRaWAN End Device .....</i>	23
<b>5. Web Configure Pages .....</b>	<b>27</b>
5.1 <i>Home .....</i>	27
5.2 <i>LoRa Settings.....</i>	28
5.2.1 <i>LoRa --&gt; LoRa .....</i>	28
5.2.2 <i>LoRa --&gt; ABP Decryption.....</i>	29
5.3 <i>LoRaWAN Settings.....</i>	30
5.3.1 <i>LoRaWAN --&gt; LoRaWAN.....</i>	30

5.3.2	LoRaWAN --> Amazon AWS-IoT .....	30
5.3.3	LoRaWAN --> LORIoT .....	30
5.4	MQTT Settings .....	32
5.5	System .....	33
5.5.1	System --> System Overview .....	33
5.5.2	System --> General ( login settings) .....	33
5.5.3	System --> Network .....	35
5.5.4	System --> WiFi .....	36
5.5.5	System --> Network Status.....	36
5.5.6	System --> Remote Mgnt & Auto Update .....	37
5.5.7	System --> Firmware Upgrade .....	39
5.5.8	System --> Reboot/Reset .....	40
5.5.9	System --> Package Maintain .....	41
5.6	LogRead.....	42
5.6.1	LogRead --> LoRa Log .....	42
5.6.2	LogRead --> Gateway Traffic .....	42
5.6.3	LogRead --> System Log .....	42
<b>6.</b>	<b>More features .....</b>	<b>44</b>
6.1	More instructions .....	44
<b>7.</b>	<b>Linux System .....</b>	<b>45</b>
7.1	SSH Access for Linux console .....	45
7.2	Edit and Transfer files .....	46
7.3	File System.....	46
7.4	Package maintain system .....	47
<b>8.</b>	<b>FAQ.....</b>	<b>48</b>
8.1	How can I configure for a customized frequency band?.....	48
8.2	Can I make my own firmware for the gateway, where can I find the source code? .....	48
8.3	Can I use 868Mhz version for 915Mhz bands?.....	48
8.4	Can I control the triangle LED?.....	48
<b>9.</b>	<b>Trouble Shooting.....</b>	<b>48</b>
9.1	I get kernel error when install new package, how to fix? .....	48
9.2	How to recover the LIG16 if firmware crash .....	49
9.3	I configured LIG16 for WiFi access and lost its IP. What to do now? .....	49

---

10.	Order Info.....	50
11.	Packing Info.....	50
12.	Support .....	50

## 1. Introduction

### 1.1 What is LIG16 Indoor LoRaWAN Gateway

The LIG16 is an open source **LoRaWAN Pico Gateway**. It lets you bridge LoRa wireless network to an IP network via WiFi, Ethernet network. The LoRa wireless allows users to send data and reach extremely long ranges at low data-rates.

The LIG16 supports **Semtech packet forwarder** and **LoRaWAN Station** connection, it is fully compatible with LoRaWAN protocol. It includes a **SX1302 LoRa concentrator**, which is the new generation baseband LoRa chip for gateway with lower current consumption and higher amount of traffic than preceding devices.

LIG16 has **pre-configured standard LoRaWAN frequency bands** to use for different countries.

User can also **customize the frequency bands** to use in their own LoRaWAN network.

LIG16 can communicate with ABP LoRaWAN end node without LoRaWAN server. System integrator can use it to integrate with their existing IoT Service without set up own LoRaWAN server or use 3rd party LoRaWAN service.

LIG16 supports **auto-provision** for mass deployment and long term maintain. System integrator can easily change the configure remotely.

#### LIG16 In a LoRaWAN IoT Network:

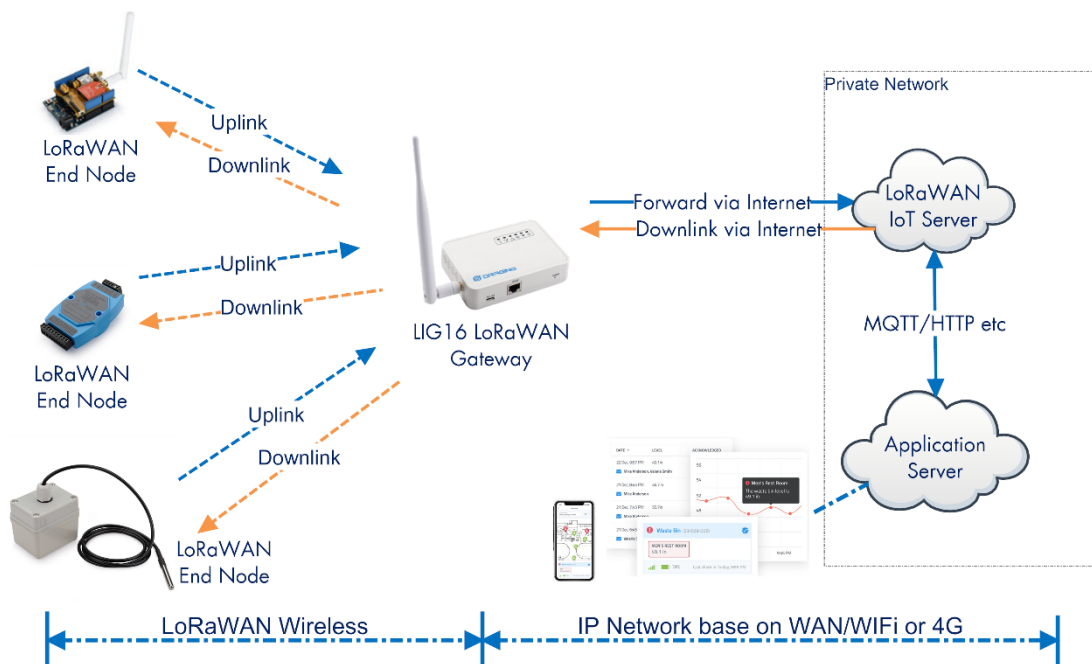



## 1.2 Specifications

### Hardware System:

Linux Part:

- 400Mhz ar9331 processor
- 64MB RAM
- 16MB Flash

### Interface:

- 10M/100M RJ45 Ports x 1
- WiFi : 802.11 b/g/n
- LoRaWAN Wireless
- Power Input: USB Type C. 5V , 2A
- USB 2.0 host connector x 1
- SX1302 + 2 x SX1250

### WiFi Spec:

- IEEE 802.11 b/g/n
- Frequency Band: 2.4 ~ 2.462GHz
- Tx power:
  - ✓ 11n tx power : mcs7/15: 11db      mcs0 : 17db
  - ✓ 11b tx power: 18db
  - ✓ 11g 54M tx power: 12db
  - ✓ 11g 6M tx power: 18db
- Wifi Sensitivity
  - ✓ 11g 54M : -71dbm
  - ✓ 11n 20M : -67dbm

### LoRa Spec:

- 70 dB CW interferer rejection at 1 MHz offset
- Up to -141 dBm sensitivity with SX1250 Tx/Rx front-end
- 125 kHz LoRa reception with:
  - ◇ 8 x 8 channels LoRa® packet detectors
  - ◇ 8 x SF5-SF12 LoRa® demodulators
  - ◇ 8 x SF5-SF10 LoRa® demodulators
- 125 /250 / 500 kHz LoRa® demodulator

### Power Consumption:

- Max: 5v, 410mA

### 1.3 Features

- ✓ Open-Source Linux system
- ✓ Managed by Web GUI, SSH via LAN or WiFi
- ✓ LoRaWAN Gateway
- ✓ Auto-Provision

### 1.4 Hardware System Structure

LIG16 System Overview:

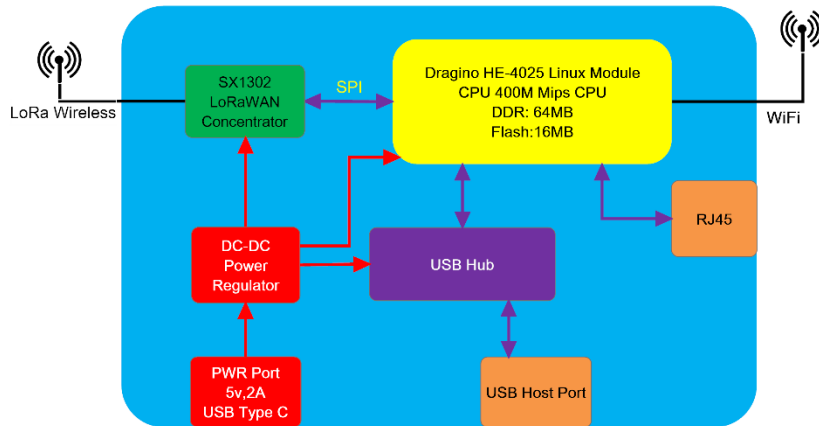







### 1.5 LIG16 Applications





## 1.6 LED Indicators

LIG16 has totally 6 LEDs:

- **Power LED** : This **YELLOW LED** will be **solid on** if the device is properly powered.
- **HEART LED** : This **GREEN LED** will be solid on if there is LoRaWAN connection.
- **SYS LED** : This **LED** will show different colors on different state:
  - ✓ **ON**: device have Internet connection.
  - ✓ **BLINKING**: a) Device has internet connection but no LoRaWAN Connection. or b) Device is in booting stage, in this stage, it will **BLINKING** for several seconds.
  - ✓ **OFF**: device doesn't have Internet connection.
- **TRIANGLE LED** : No Function.
- **ETH LED** : This LED shows the ETH interface physical connection status.
- **WiFi LED** : This LED shows the WiFi interface connection status.

## 2. Access and configure LIG16

The LIG16 is configured as a WiFi Access Point by default. User can access and configure the LIG16 after connecting to its WiFi network, or via its Ethernet ports.

### 2.1 Find IP address of LIG16

#### 2.1.1 Connect via WiFi



At the first boot of LIG16, it will auto generate an unsecure WiFi network call **dragino-xxxxxx**

the password is: **dragino+dragino**

User can use the laptop to connect to this WiFi network. The laptop will get an IP address 10.130.1.xxx and the LIG16 has the default IP **10.130.1.1**



#### 2.1.2 Connect via WAN port with DHCP IP from router

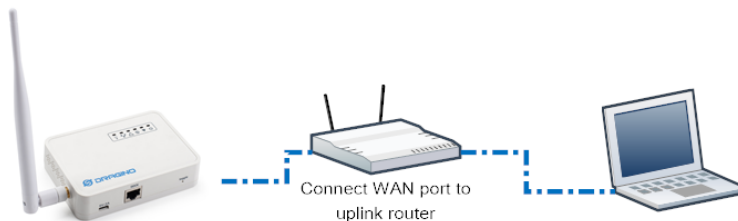

Alternatively, connect the LIG16 **WAN port** to your router and LIG16 will obtain an IP address from your router. In the router's management portal, you should be able to find what IP address the router has assigned to the LIG16. You can also use this IP to connect.

### 2.1.3 Connect via WiFi with DHCP IP from router

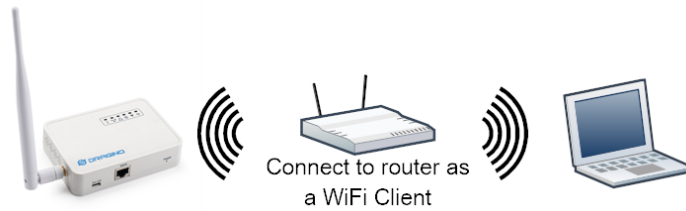

If the LIG16 already connect to the router via WiFi, use can use the WiFi IP to connect to LIG16.

### 2.1.4 Connect via WAN port by fall back ip

The **WAN port** also has a [fall back ip address](#) for access if user doesn't connect to uplink router.

## 2.2 Access Configure Web UI

### Web Interface

Open a browser on the PC and type the LIG16 ip address (depends on your connect method)

<http://10.130.1.1/> (Access via LIG16's WiFi AP network)

or

[http://IP\\_ADDRESS](http://IP_ADDRESS) or [http://IP\\_ADDRESS:8000](http://IP_ADDRESS:8000) (If the IP is assigned by uplink router)

You will see the login interface of LIG16 as shown below.

The account details for Web Login are:

**User Name:** root

**Password:** dragino

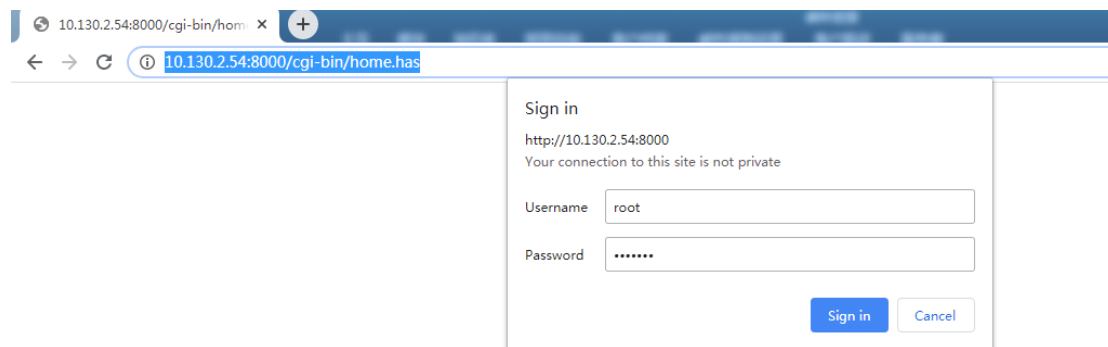

### 3. Typical Network Setup

#### 3.1 Overview

LIG16 supports flexible network set up for different environment. This section describes the typical network topology can be set in LIG16. The typical network set up includes:

- ✓ WAN Port Internet Mode
- ✓ WiFi Client Mode
- ✓ WiFi AP Mode

#### 3.2 Use WAN port to access Internet

By default, LIG16 is set to use the WAN port to connect to an upstream network. When you connect the LIG16's WAN port to an upstream router, LIG16 will get an IP address from the router and have Internet access via the upstream router. The network status can be checked in the [home page](#):

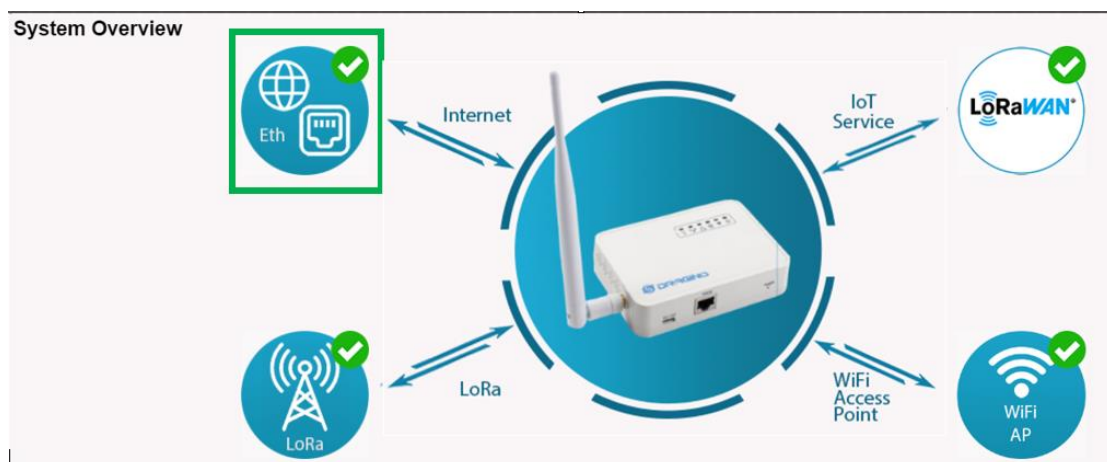

### 3.3 Access Internet as a WiFi Client.

In the WiFi Client Mode, LIG16 acts as a WiFi client and gets DHCP from an upstream router via WiFi.

The settings for WiFi Client is under page [System](#) → [WiFi](#) → [WiFi WAN Client Settings](#)

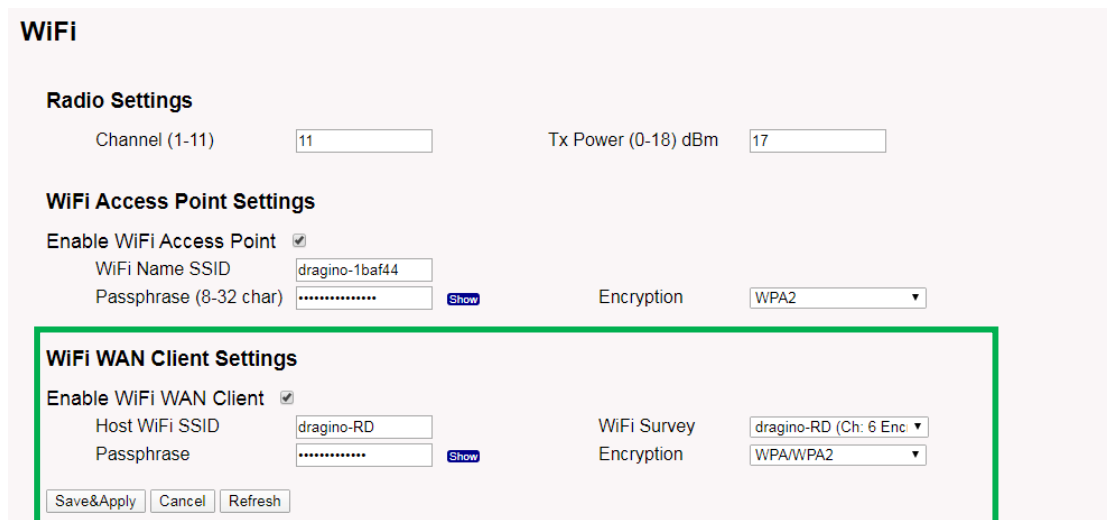

**WiFi**

**Radio Settings**

Channel (1-11)  Tx Power (0-18) dBm

**WiFi Access Point Settings**

Enable WiFi Access Point

WiFi Name SSID

Passphrase (8-32 char)  [Show](#) Encryption

**WiFi WAN Client Settings**

Enable WiFi WAN Client

Host WiFi SSID



Passphrase  [Show](#) WiFi Survey

Encryption

In the WiFi Survey Choose the WiFi AP, and input the Passphrase then click Save & Apply to connect.

### 3.4 Check Internet connection

In the [Home](#) page, we can check the Internet connection.

- GREEN Tick  : This interface has Internet connection.
- Yellow Tick  : This interface has IP address but don't use it for internet connection.
- RED Cross  : This interface doesn't connect.



#### 4. Example : Configure as a LoRaWAN gateway

LIG16 is fully compatible with LoRaWAN protocol. It uses the legacy Semtech Packet forwarder to forward the LoRaWAN packets to server. The structure is as below.

##### LIG16 In a LoRaWAN IoT Network:

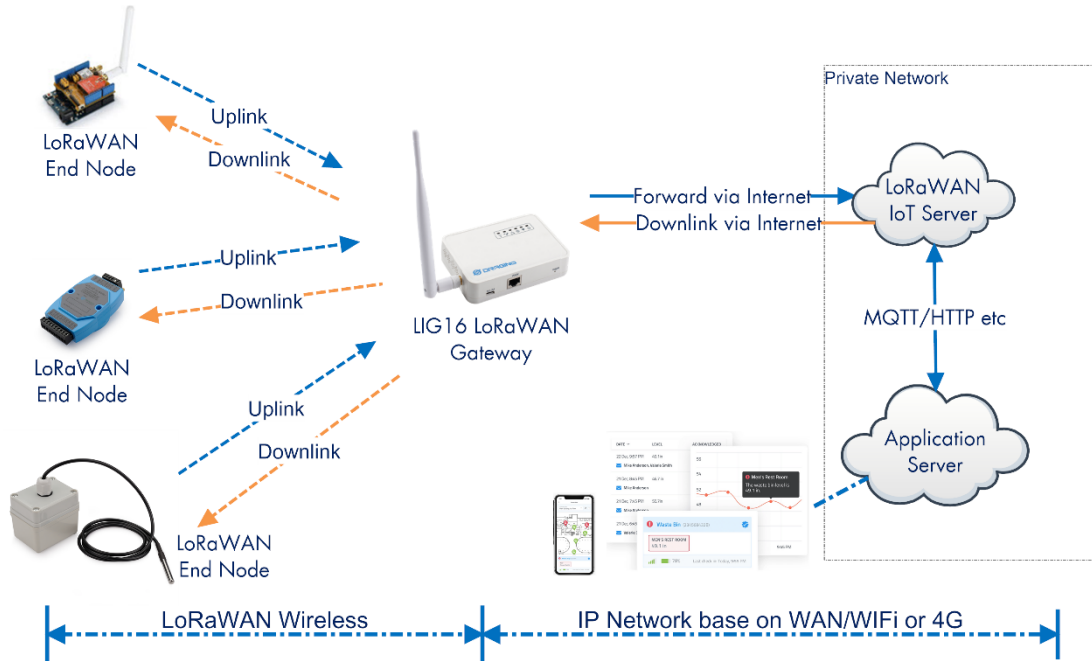

This chapter describes how to use the LIG16 to work with

[TheThingsNetwork v3\(TTN v3\) LoRaWAN Server](http://www.thethingsnetwork.org) ([www.thethingsnetwork.org](http://www.thethingsnetwork.org))

The method to work with other LoRaWAN server is similar.



## 4.1 Create a gateway in TTN v3 Server

### Step 1: Get a Unique gateway ID.

Every LIG16 has a unique gateway id. The id can be found at LoRaWAN page:

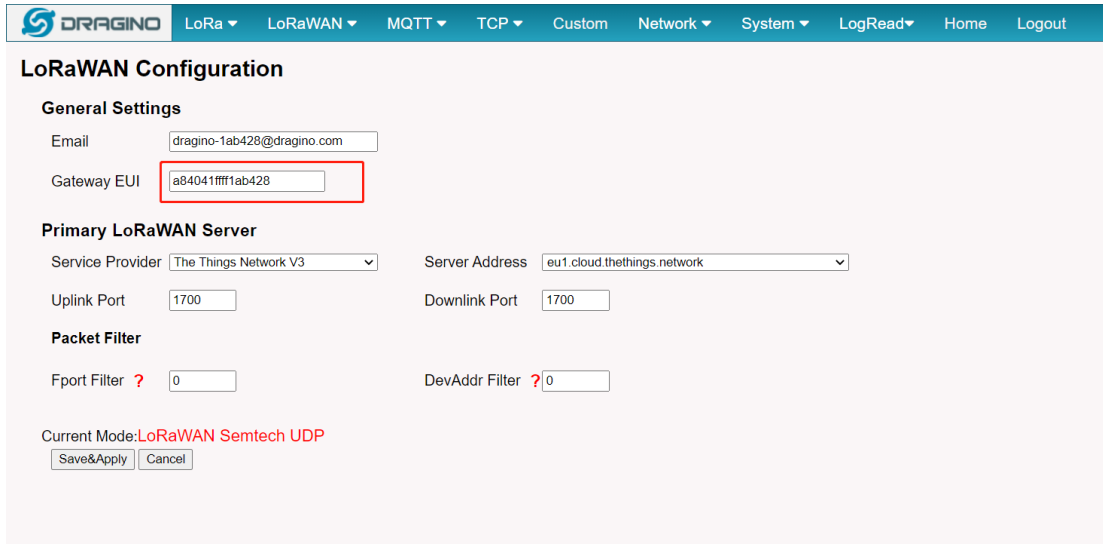

The screenshot shows the 'LoRaWAN Configuration' page. Under 'General Settings', the 'Gateway EUI' field contains the value 'a84041ffff1ab428'. Other fields include 'Email' (dragino-1ab428@dragino.com), 'Primary LoRaWAN Server' (Service Provider: The Things Network V3, Server Address: eu1.cloud.thethings.network), 'Uplink Port' (1700), 'Downlink Port' (1700), 'Packet Filter' (Fport Filter: 0, DevAddr Filter: 0), and 'Current Mode: LoRaWAN Semtech UDP'. There are 'Save&Apply' and 'Cancel' buttons at the bottom.

The gateway id is: **a84041ffff1ab428**

### Step 2: Sign up a user account in TTN server

<https://account.thethingsnetwork.org/register>

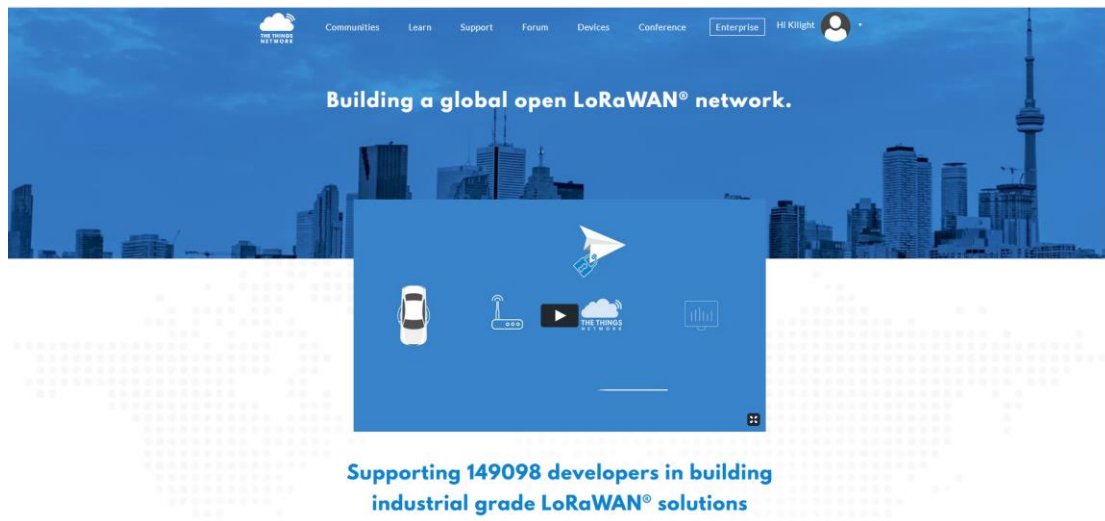

### Step 3: Choose the TTNv3 Cluster Picker

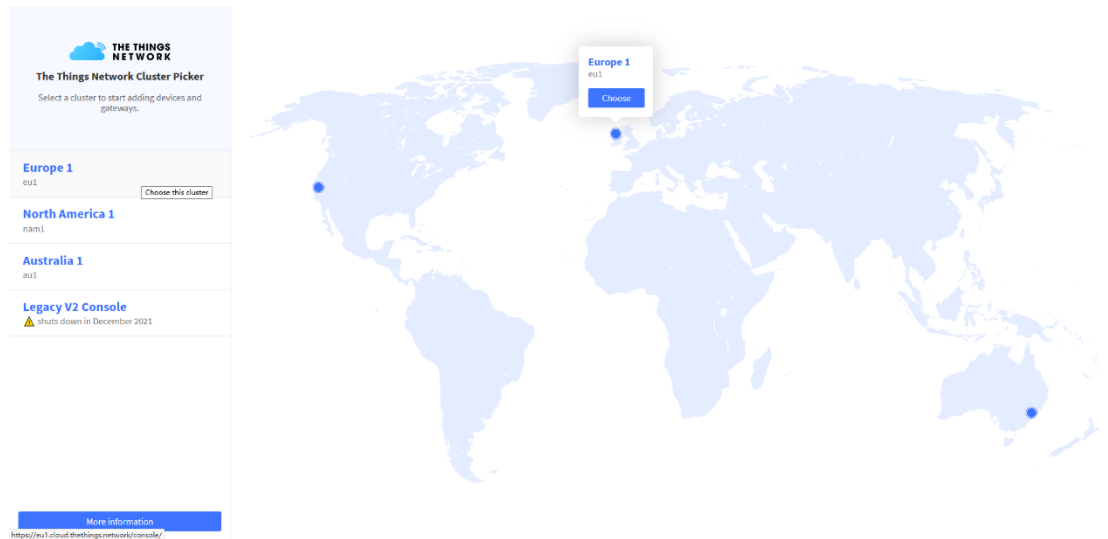

**Note: Choose the cluster corresponds to a specific Gateway server address**

- Europe 1 **corresponding Gateway server address:** eu1.cloud.thethings.network
- North America 1 **corresponding Gateway server address:** nam1.cloud.thethings.network
- Australia 1 **corresponding Gateway server address:** au1.cloud.thethings.network
- Legacy V2 Console : **TTN v2 shuts down in December 2021**

### Step 4: Create a Gateway

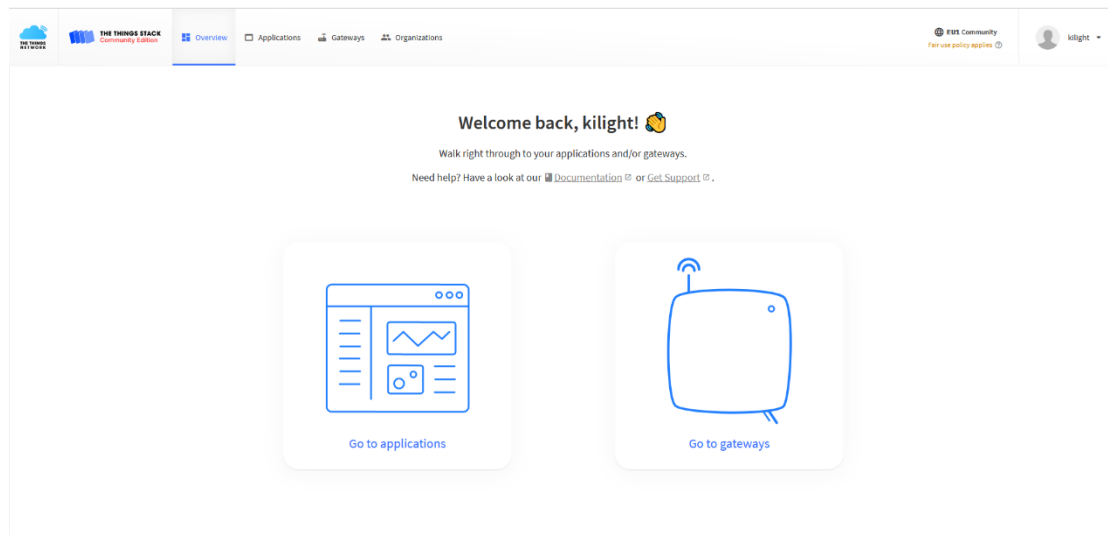

Click the Gateway icon and then click Add gateway.

Open the following page:

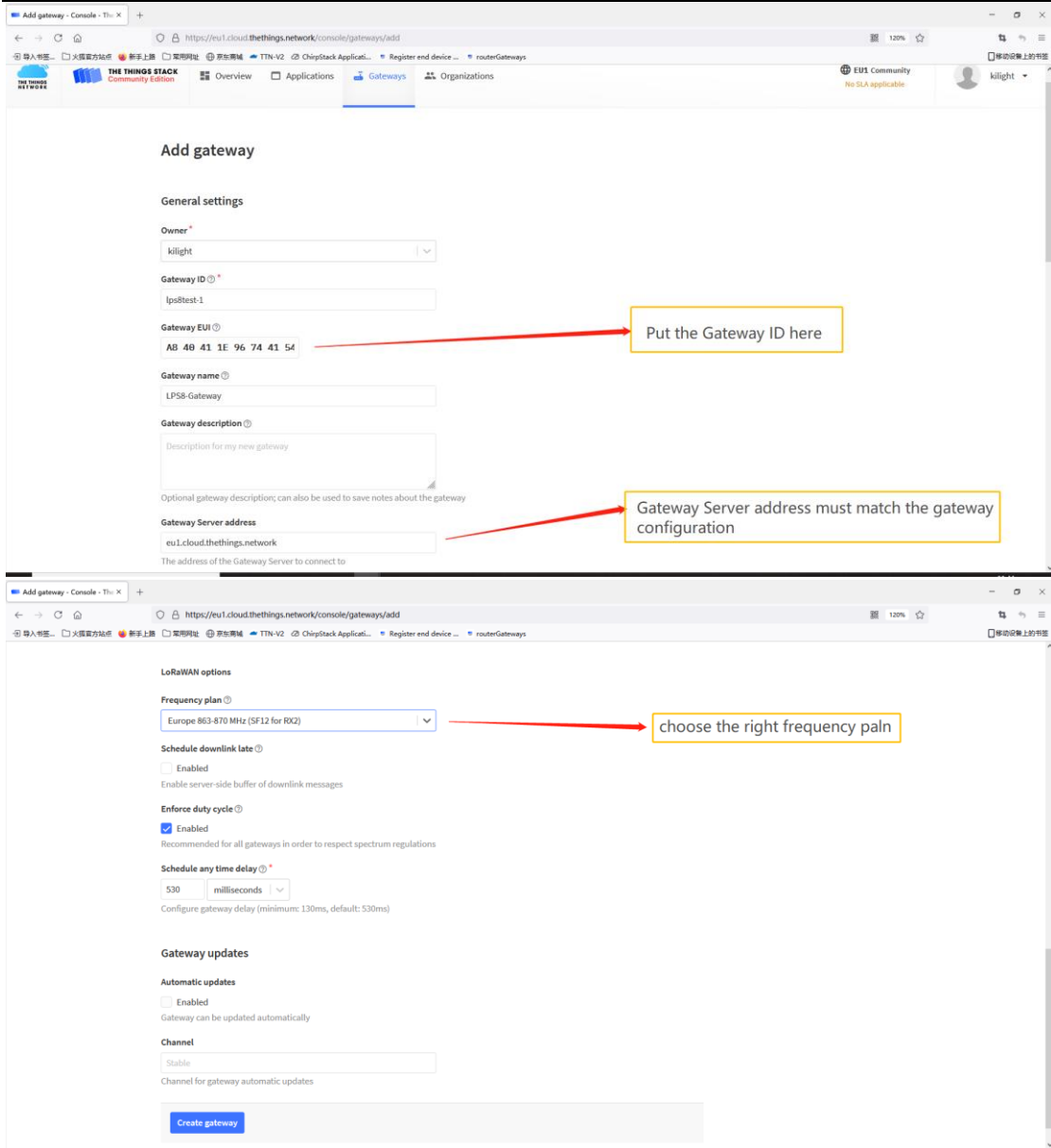

**Notice:** Gateway Server address must match the gateway configuration, otherwise you will have problem for End Node to join the network.

[https://www.thethingsnetwork.org/docs/gateways/packet-forwarder/semtech-udp.html#connect-a-gateway\\_server-addresses](https://www.thethingsnetwork.org/docs/gateways/packet-forwarder/semtech-udp.html#connect-a-gateway_server-addresses)

After create the gateway, we can see the gateway info, as below

The screenshot shows the 'LIG16-Gateway' configuration page. At the top, there's a navigation bar with 'Overview', 'Applications', 'Gateways', and 'Organizations'. The 'Gateways' tab is active. Below the navigation, there's a sidebar with options like 'Overview', 'Live data', 'Location', 'Collaborators', 'API keys', and 'General settings'. The main content area shows the gateway details:

- General Information:** Gateway ID: l1g16gateway, Gateway EUI: AB 40 41 FF FF 1A B4 74, Gateway description: None, Created at: Jan 19, 2022 14:57:35, Last updated at: Jan 19, 2022 14:57:35, Gateway Server address: eu1.cloud.thethings.network.
- LoRaWAN Information:** Frequency plan: EU\_863\_870\_TTN, Global configuration: Download global\_conf.json.
- Live data:** Shows a 'Create gateway' button and a timestamp of 14:57:35.
- Location:** A world map is shown with the text 'No location information available'.

## 4.2 Configure LIG16 to connect to TTN v3

You can now configure the LIG16 to let it connect to TTN network V3. Make sure your LIG16 has a working Internet Connection first.

Choose the right server provider and click **Save&Apply**

The screenshot shows the 'LoRaWAN Configuration' page. The navigation bar includes 'LoRa', 'LoRaWAN', 'MQTT', 'TCP', 'Custom', 'Network', 'System', 'LogRead', 'Home', and 'Logout'. The 'LoRaWAN' tab is active. The configuration fields are:

- General Settings:** Email: dragino-1ab428@dragino.com, Gateway EUI: a84041ffff1ab474.
- Primary LoRaWAN Server:** Service Provider: The Things Network V3, Server Address: eu1.cloud.thethings.network, Uplink Port: 1700, Downlink Port: 1700.
- Packet Filter:** Fport Filter: 0, DevAddr Filter: 0.
- Current Mode:** LoRaWAN Semtech UDP.

The 'Save&Apply' button is highlighted in red.

**Note:** The server address must match the router you choose in TTN.

In the home page, we can see the LoRaWAN connection is ready now.



In TTN v3 portal, we can also see the gateway is connected.

The screenshot shows the TTN v3 portal interface for a gateway named "LIG16-Gateway". The main content area displays the following information:

- General information:**
  - Gateway ID: lig16gateway
  - Gateway EUI: AB 40 41 FF FF 1A B4 74
  - Gateway description: None
  - Created at: Jan 19, 2022 14:57:35
  - Last updated at: Jan 19, 2022 14:57:35
  - Gateway Server address: eu1.cloud.thethings.network
- LoRaWAN information:**
  - Frequency plan: EU\_863\_870\_TTN
  - Global configuration: Download global\_conf.json
- Live data:**
  - 15:04:05: Receive uplink message DevAddr: 28 09 68 91 FCnt: 588 FP
  - 15:03:52: Receive uplink message JoinEUI: AB 40 41 00 00 00 01 00 DevE
  - 15:03:51: Connect gateway
  - 14:57:35: Create gateway
- Location:** A world map showing "No location information available".

### 4.3 Configure frequency

We also need to set the frequency plan in LIG16 to match the LoRaWAN end node we use, so to receive the LoRaWAN packets from the LoRaWAN sensor.

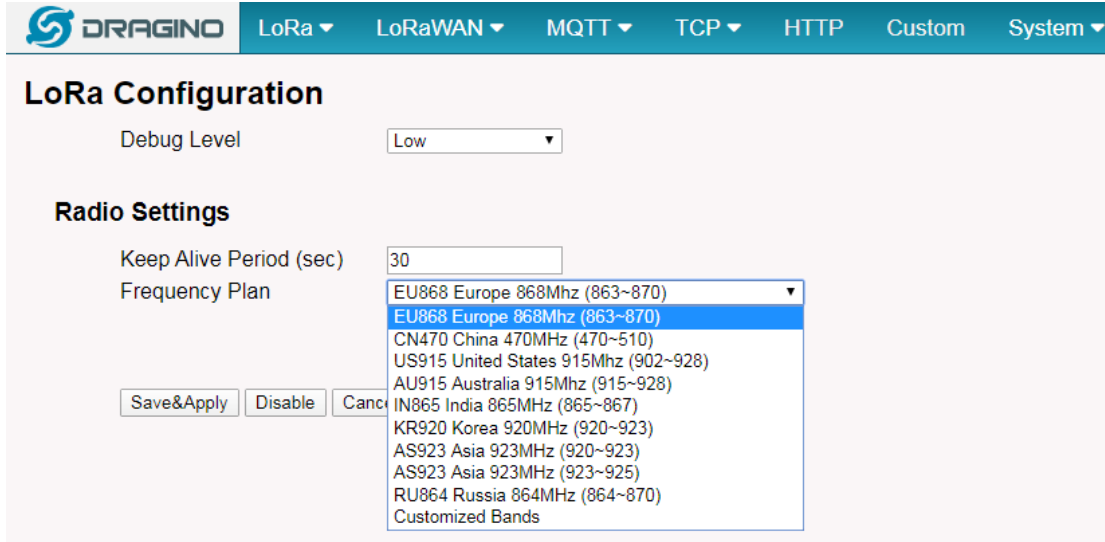

In logread page, user can check the frequency actually used.

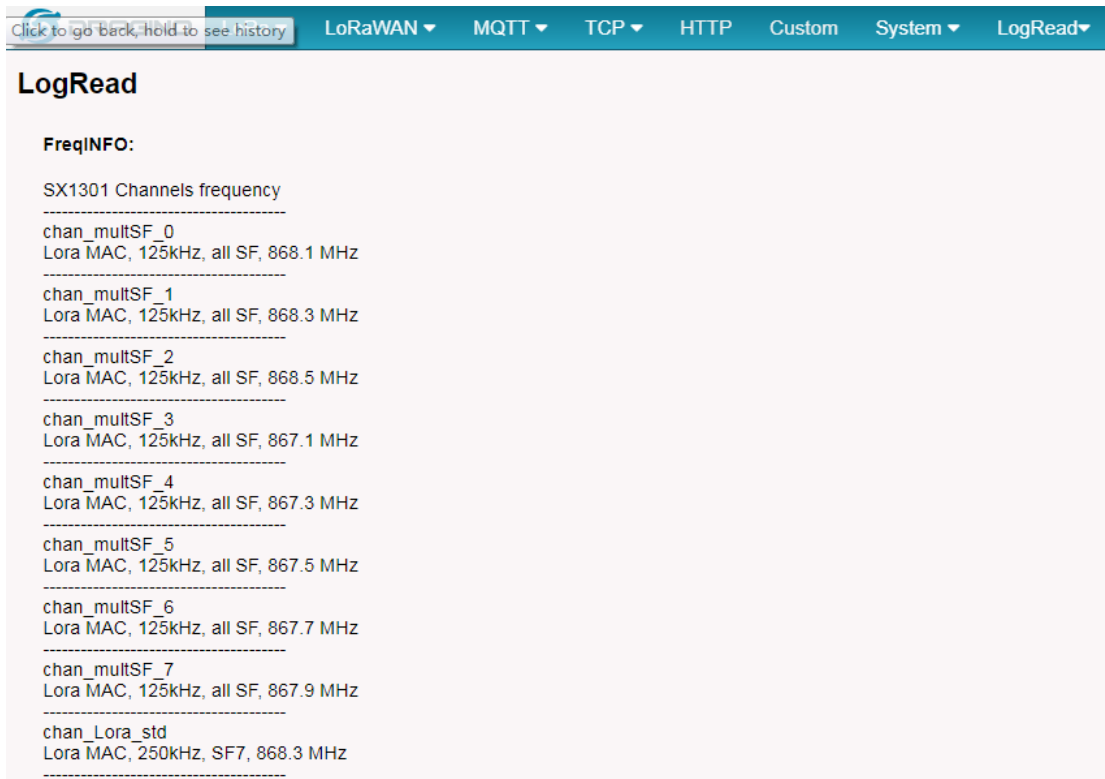

After doing above LIG16 will be able to act as LoRaWAN Gateway. Below section shows how to add a LoRaWAN End device in this LoRaWAN network and see the data from TTN.

We use [LT-2222-L](#) as a reference below, for other LoRaWAN devices will be more or less the same.

#### 4.4 Add a LoRaWAN End Device



**Step 1:** Create a Device definition in TTN v3 with the OTAA keys from the example LT-2222-L IO Controller device.

Three codes are required to define the device in TTN v3:

- ✓ DEV EUI - Unique ID code for a particular device.
- ✓ APP EUI - ID code for an Application defined in TTN v3.
- ✓ APP Key - Unique key to secure communications with a particular device.

A set of these codes are stored in each device by the manufacturer as the default codes for that particular device. Each device is shipped with a sticker with the default Device EUI as shown below.



Note: You may be able to change these codes in a device by using a configuration facility on the device e.g. the LT-22222 uses a serial port access and a series of AT commands. Changing the codes may be necessary in the case where you have to use codes assigned by a LoRa WAN server.

For the TTN v3 server, you can use the codes set in the device as in the following example.

Select **Add Application** to open the screen below.

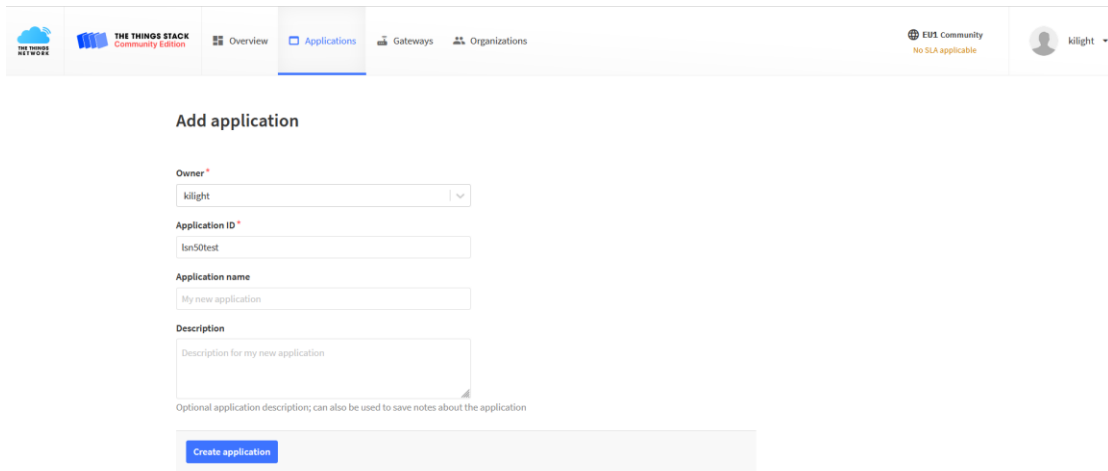

Open the **Application** select **Add end device**

Start Register the end device

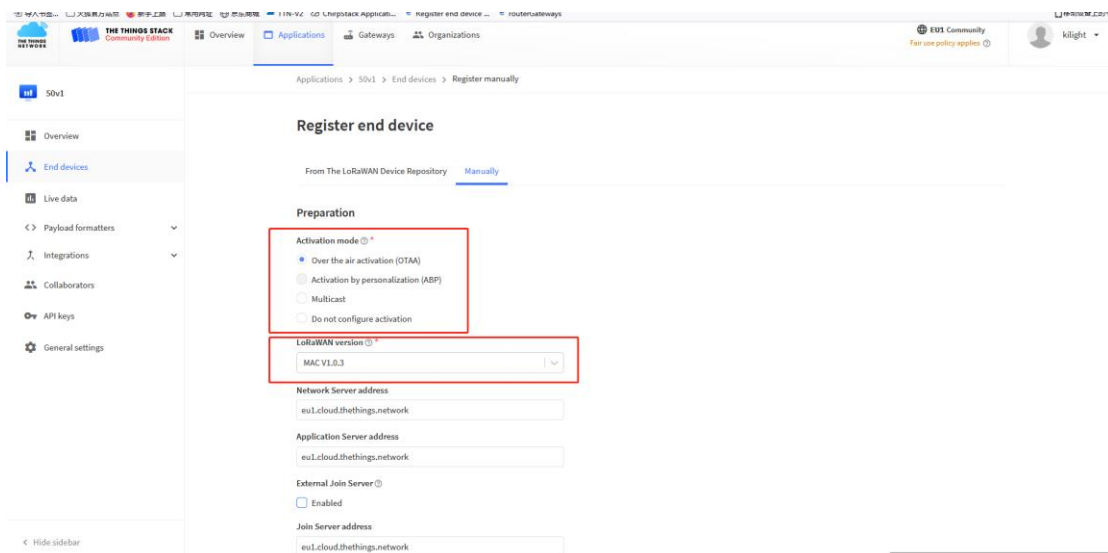

Select OTAA activation mode

The LoRaWAN version for your device should be provided by the manufacturer in a datasheet as LoRaWAN version or LoRaWAN specification. The most commonly used LoRaWAN versions are v1.0.2 and v1.0.3.



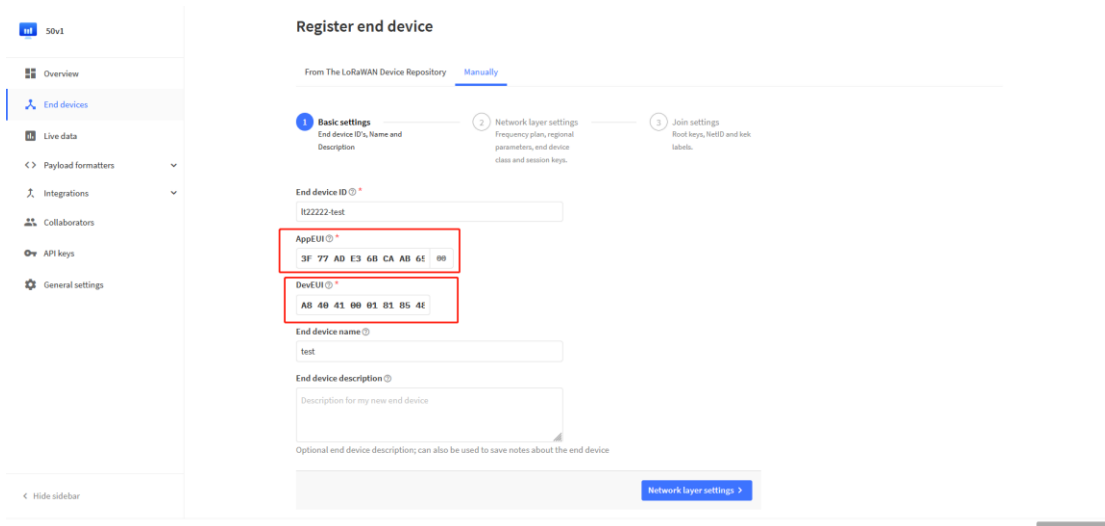

First, input the End device ID, AppEUI and DevEUI.

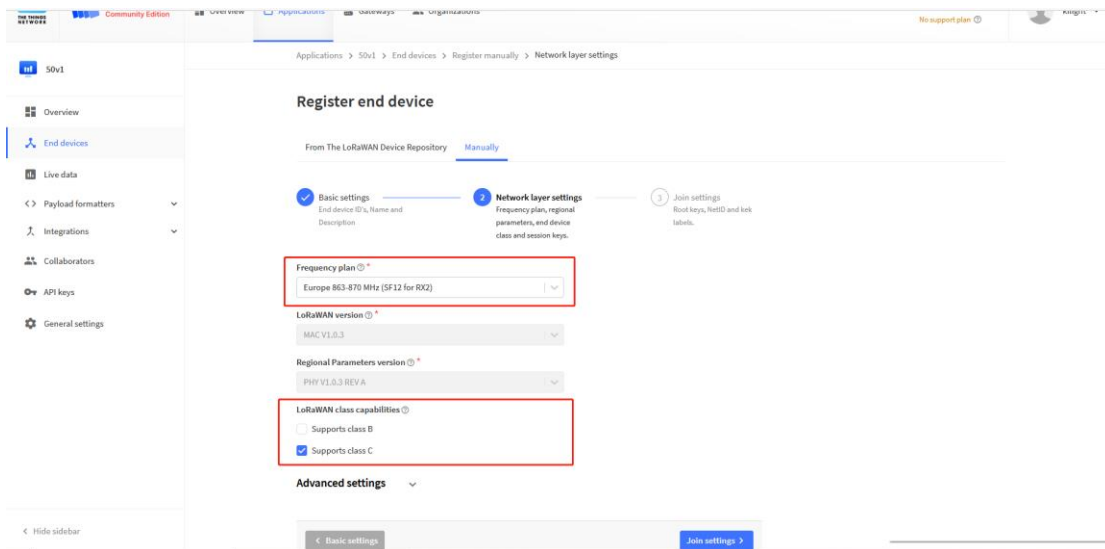

Secondly, choose the corresponding frequency and LoRaWAN class capabilities.

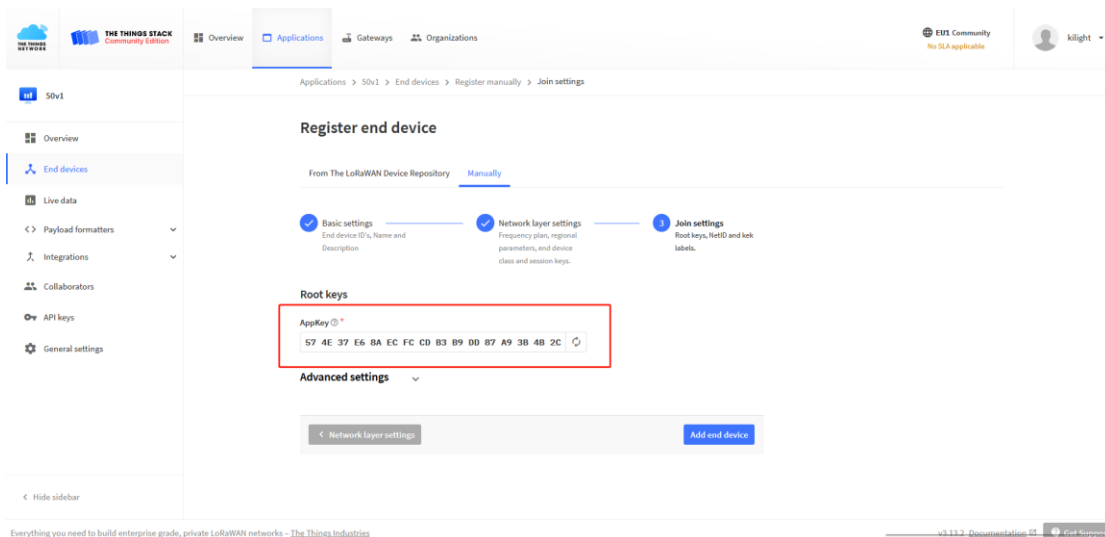

Finally, Application layer settings input the corresponding AppKey. Before saving the configuration, check that the data matches the device.

**Step 2:** Power on LT-22222-L device and it will automatically join the TTN network. After joining successfully, it will start to upload messages to the TTN v3. Select the Live data tab and you will see the data appearing in the panel.

Note that it may take some time for the device data to appear in the TTN v3 display.

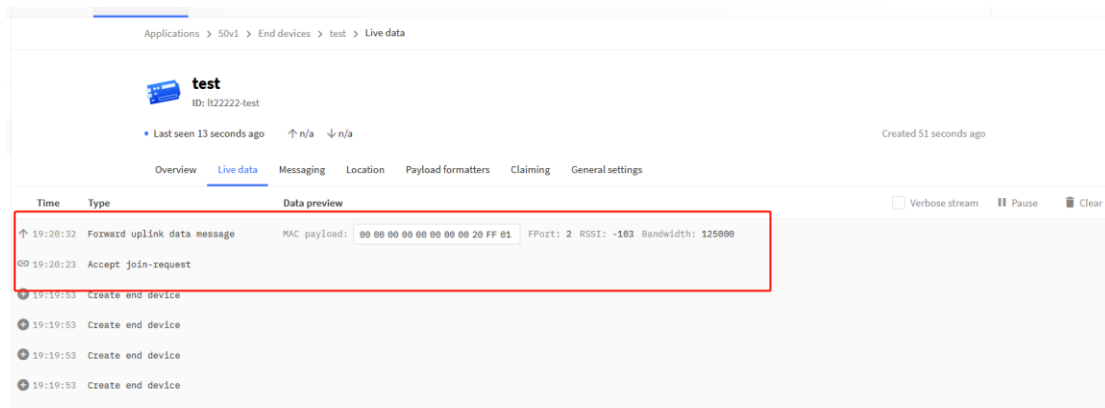

## 5. Web Configure Pages

### 5.1 Home

Shows the system running status:

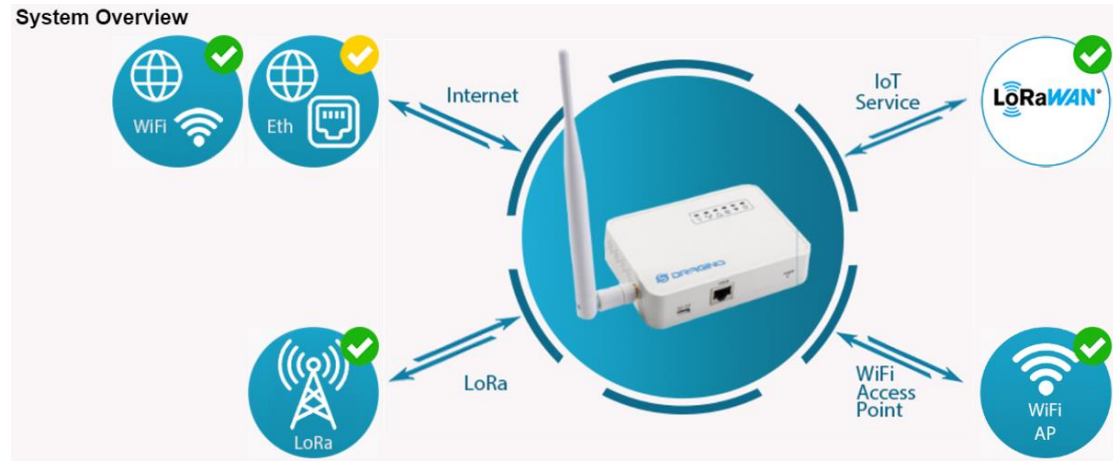

## 5.2 LoRa Settings

### 5.2.1 LoRa --> LoRa

This page shows the LoRa Radio Settings. There are a set of default frequency band according to LoRaWAN protocol, and user can customize the band\* as well.

Different LIG16 hardware version can support different frequency range:

- **868**: valid frequency: 863Mhz ~ 870Mhz. for bands EU868, RU864, IN865 or KZ865.
- **915**: valid frequency: 902Mhz ~ 928Mhz. for bands US915, AU915, AS923 or KR920

After user choose the frequency plan, he can see the actually frequency in used by checking the page **LogRead --> LoRa Log**

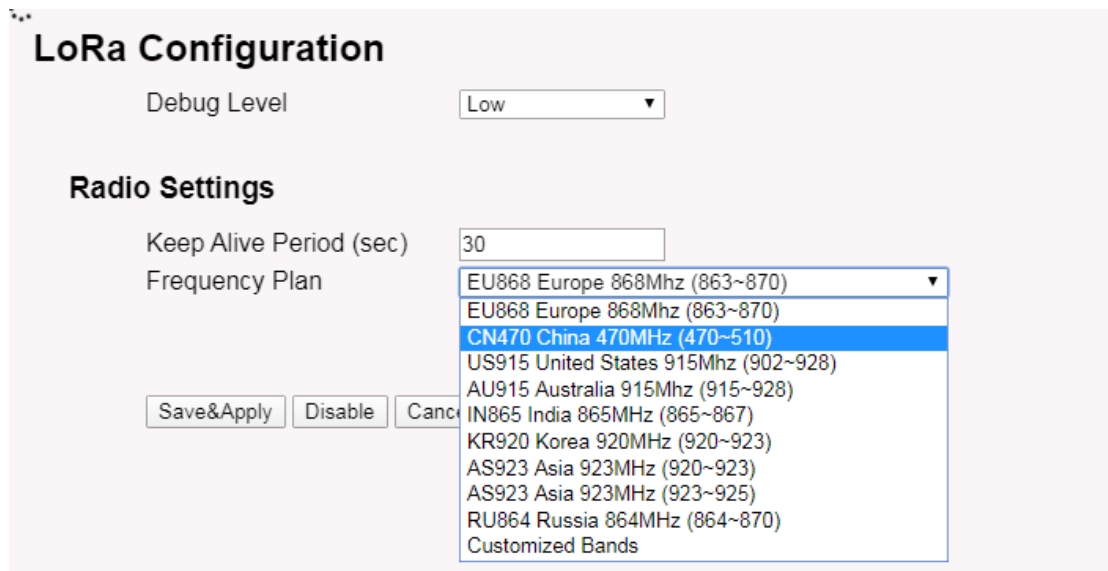

**LoRa Configuration**

Debug Level: Low

**Radio Settings**

Keep Alive Period (sec): 30

Frequency Plan: **CN470 China 470MHz (470~510)**

Save&Apply | Disable | Cancel

- EU868 Europe 868Mhz (863~870)
- EU868 Europe 868Mhz (863~870)
- CN470 China 470MHz (470~510)**
- US915 United States 915Mhz (902~928)
- AU915 Australia 915Mhz (915~928)
- IN865 India 865MHz (865~867)
- KR920 Korea 920MHz (920~923)
- AS923 Asia 923MHz (920~923)
- AS923 Asia 923MHz (923~925)
- RU864 Russia 864MHz (864~870)
- Customized Bands

Note \*: See this instruction for how to customize frequency band:

[http://wiki.dragino.com/index.php?title=Customized\\_Frequency\\_Band\\_for\\_Gateway](http://wiki.dragino.com/index.php?title=Customized_Frequency_Band_for_Gateway)

### 5.2.2 LoRa --> ABP Decryption

The LIG16 can communicate with LoRaWAN ABP End Node without the need of LoRaWAN server. It can be used in some cases such as:

- No internet connection.
- User wants to get data forward in gateway and forward to their server based on MQTT/HTTP, etc. (Combine ABP communication method and MQTT forward together).

Detail of this feature:

[http://wiki.dragino.com/index.php?title=Communication\\_with\\_ABP\\_End\\_Node](http://wiki.dragino.com/index.php?title=Communication_with_ABP_End_Node)

#### Decrypt ABP End Node Packets

Enable ABP Decryption

##### Add Key

Dev ADDR:   
APP Session Key:   
Network Session Key:

##### Delete Key

Dev ADDR:

##### ABP Keys:

Dev ADDR	APP Session Key	Network Session Key
----------	-----------------	---------------------

## 5.3 LoRaWAN Settings

### 5.3.1 LoRaWAN --> LoRaWAN

This page is for the connection set up to a general LoRaWAN Network server such as: [TTN](#), [ChirpStack](#) etc

### LoRaWAN Configuration

**Server Settings**

LoRaWAN Service Provider	<input type="text" value="TTN-router-EU"/>		
Gateway ID	<input type="text" value="a84041ffff1d25dc"/>		
Server Port Upstream	<input type="text" value="1700"/>	Latitude	<input type="text" value="22.705177"/>
Server Port Downstream	<input type="text" value="1700"/>	Longitude	<input type="text" value="114.243423"/>

Email

**Packet Filter**

Eport Filter

Note

\*\* : Packet filter is to drop the unwanted LoRaWAN packet, instruction see here:

See [http://wiki.dragino.com/index.php?title=Main\\_Page#Filter\\_unwanted\\_LoRaWAN\\_packets](http://wiki.dragino.com/index.php?title=Main_Page#Filter_unwanted_LoRaWAN_packets)

### 5.3.2 LoRaWAN --> Amazon AWS-IoT

DRAGINO
LoRa ▾ LoRaWAN ▾ MQTT ▾ TCP ▾ Custom Network ▾ System ▾ LogRead ▾

### Amazon AWS IoT -- LoRaWAN

**Settings**

CUPS URI	<input type="text" value="example: https://xxxxxxxx.cups.lorawan.us-east-1.amazonaws.com:443"/>		
Email	<input type="text" value="dragino-1ec39c@dragino.com"/>		
Gateway ID	<input type="text" value="a84041ffff1ec39c"/>		
CUPS trust	Not Found	<input type="button" value="選擇檔案"/> 未選擇任何檔案	<input type="button" value="Upload_CUPS_Trust"/>
Private key	Not Found	<input type="button" value="選擇檔案"/> 未選擇任何檔案	<input type="button" value="Upload_Private_key"/>
Cert pem	Not Found	<input type="button" value="選擇檔案"/> 未選擇任何檔案	<input type="button" value="Upload_Cert_pem"/>

Current Mode: **LoRaWAN Semtech UDP** Click Save & Apply will change to mode: **LoRaWAN Station for AWS**

Please see this instruction to know more detail and demo for how to connect to AWS-IoT

LoRaWAN Core: [http://wiki.dragino.com/index.php?title=Notes\\_for\\_AWS-IoT-Core](http://wiki.dragino.com/index.php?title=Notes_for_AWS-IoT-Core)

### 5.3.3 LoRaWAN --> LORIIOT

Settings to communicate to LORIIOT LoRaWAN Network Server: <https://www.loriot.io/>

Instruction: [http://wiki.dragino.com/index.php?title=Notes\\_for\\_LORIIOT](http://wiki.dragino.com/index.php?title=Notes_for_LORIIOT)

## LORIoT Client Configuration

**LORIoT software not installed.**

Server Address

Server Port

Client Certificate

Client Key

CA File

Device EUI: A840411D25DF

[Certificate Management](#)

### 5.4 MQTT Settings

If end nodes work in ABP mode, user can configure LIG16 to transfer the data to MQTT broker, Instruction:

[http://wiki.dragino.com/index.php?title=Main\\_Page#MQTT\\_Forward\\_Instruction](http://wiki.dragino.com/index.php?title=Main_Page#MQTT_Forward_Instruction)

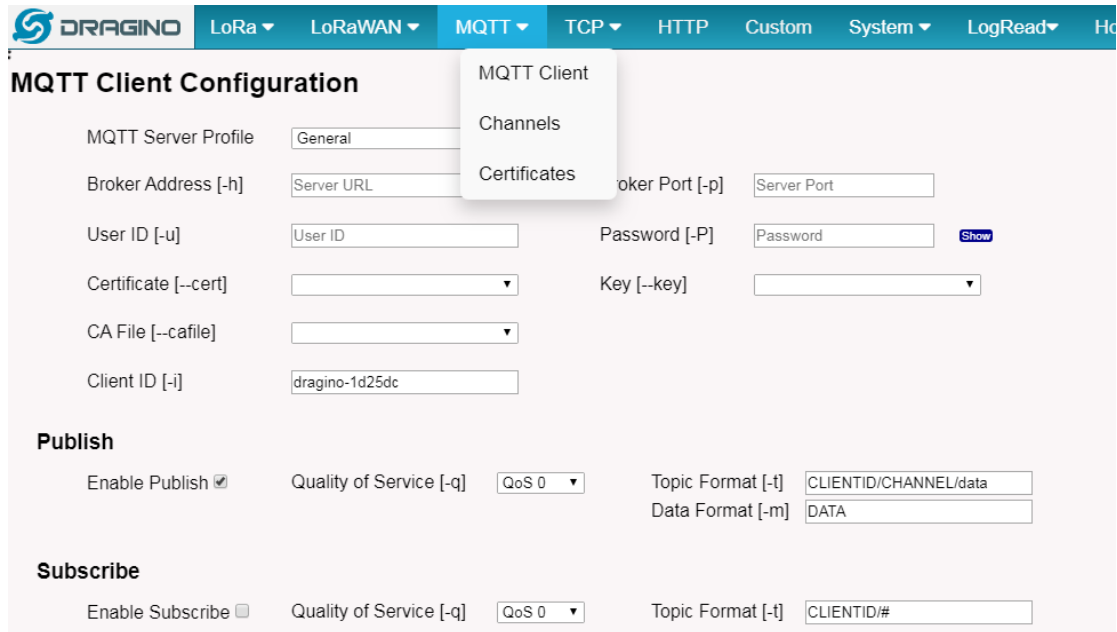

**MQTT Client Configuration**

MQTT Server Profile:

Broker Address [-h]:  Broker Port [-p]:

User ID [-u]:  Password [-P]:  [Show](#)

Certificate [--cert]:  Key [--key]:

CA File [--cafile]:

Client ID [-i]:

**Publish**

Enable Publish  Quality of Service [-q]:  Topic Format [-t]:   
Data Format [-m]:

**Subscribe**

Enable Subscribe  Quality of Service [-q]:  Topic Format [-t]:



## 5.5 System

### 5.5.1 System --> System Overview

Shows the system info:

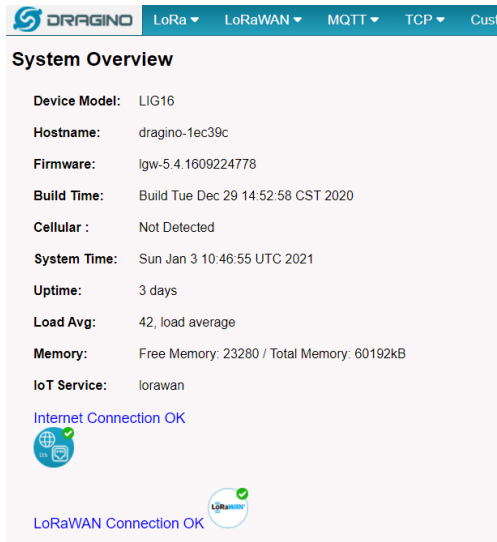

**System Overview**

- Device Model: LIG16
- Hostname: dragino-1ec39c
- Firmware: lgw-5.4.1609224778
- Build Time: Build Tue Dec 29 14:52:58 CST 2020
- Cellular : Not Detected
- System Time: Sun Jan 3 10:46:55 UTC 2021
- Uptime: 3 days
- Load Avg: 42, load average
- Memory: Free Memory: 23280 / Total Memory: 60192kB
- IoT Service: lorawan

Internet Connection OK

LoRaWAN Connection OK

### 5.5.2 System --> General ( login settings)

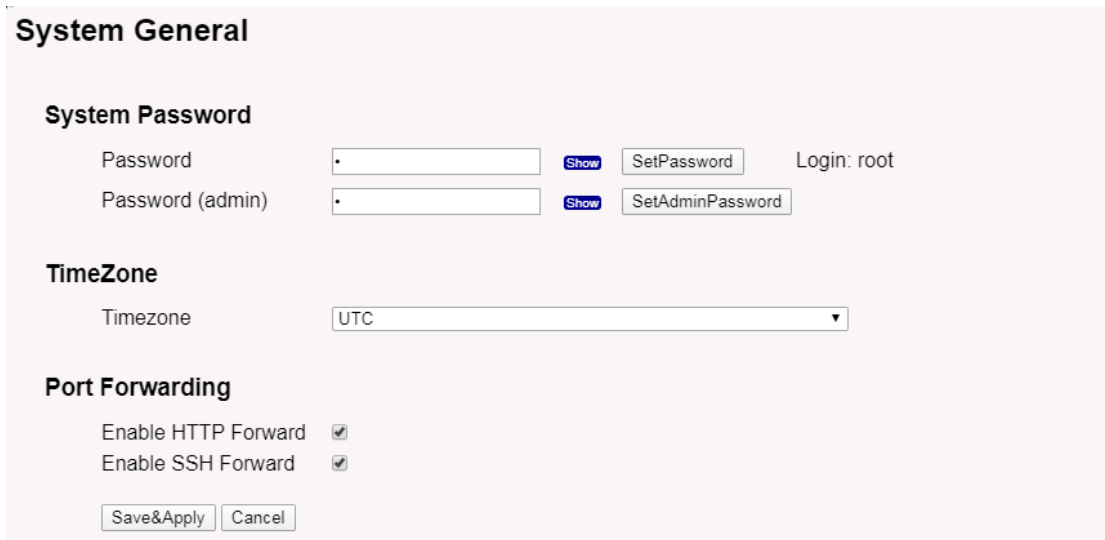

**System General**

**System Password**

Password    Login: root

Password (admin)

**TimeZone**

Timezone

**Port Forwarding**

Enable HTTP Forward

Enable SSH Forward

#### **System Password:**

There are two logins for LIG16: **root /dragino** or **admin /dragino**. Both root and admin have the same right for WEB access. But root user has also the right to access via SSH to Linux system. admin only able to access WEB interface.

This page can be used to set the password for them.

#### **Timezone:**

Set device timezone.

**Port forwarding:**

Enable/Disable the HTTP and SSH access via WAN interface.

### 5.5.3 System --> Network

**Network**

**LAN Settings**

IP Address  Gateway

Netmask  DNS

**WAN Settings**

Enable DHCP

**WiFi WAN Settings**

Enable DHCP

#### **LAN Settings:**

When the LIG16 has the AP enable, LAN settings specify the network info for LIG16's own network.

#### **WAN Settings:**

Setting for LIG16 WAN port

#### **WiFi Settings:**

Setting for LIG16 WiFi IP when use it as WiFi Client

### 5.5.4 System --> WiFi

LIG16 WiFi Settings.

**WiFi**

**Radio Settings**

Channel (1-11)  Tx Power (0-18) dBm

**WiFi Access Point Settings**

Enable WiFi Access Point

WiFi Name SSID

Passphrase (8-32 char)  [Show](#) Encryption

**WiFi WAN Client Settings**

Enable WiFi WAN Client

Host WiFi SSID

Passphrase  [Show](#) WiFi Survey

Encryption

### 5.5.5 System --> Network Status

**System Status**

**Network / WiFi Status**

```

Network
-----
Lan IP Address:
  inet addr:10.130.1.1 Bcast:10.130.1.255 Mask:255.255.255.0

Eth WAN IP Address:
  inet addr:10.130.2.207 Bcast:10.130.2.255 Mask:255.255.255.0
  inet addr:172.31.255.254 Bcast:172.31.255.255 Mask:255.255.255.252
WiFi WAN IP Address:
Cellular:

Bridge:
bridge name bridge id          STP enabled interfaces
br-lan      7fff.a840411d25df  no          eth0
              wlan0

WiFi
----
wlan0  ESSID:"dragino-1d25dc"
       Access Point: A8:40:41:1D:25:DC
       Mode: Master Channel: 11 (2.462 GHz)
       Tx:Power: 17 dBm Link Quality: unknown/70
       Signal: unknown Noise: -95 dBm
       Bit Rate: unknown
       Encryption: WPA2 PSK (CCMP)
       Type: nl80211 HW Mode(s): 802.11bgn
    
```

### 5.5.6 System --> Remote Mgmt & Auto Update

Auto Provision is the feature for batch configure and remote management. It can be used in below two cases:

Case 1:  
Batch  
configure  
gateways  
before  
deploy

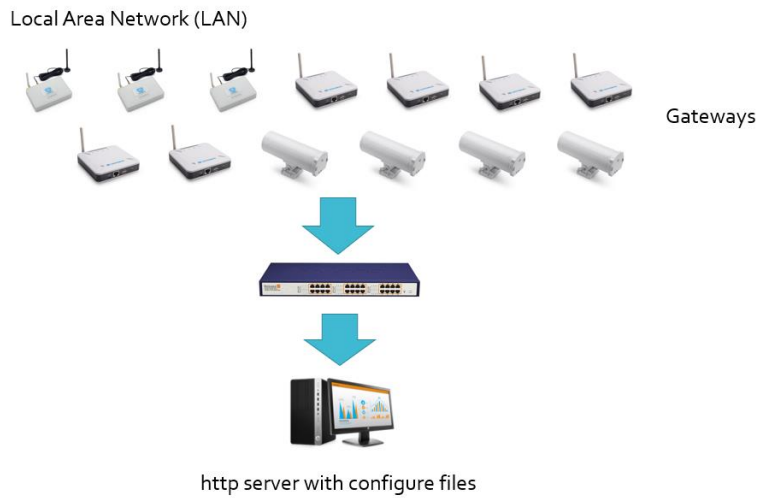

Case 2:  
Maintain  
gateway  
configure  
from  
cloud

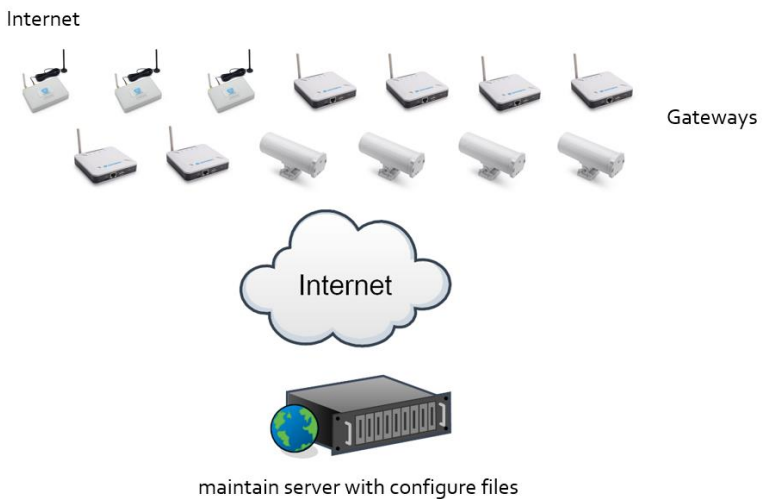

How it works

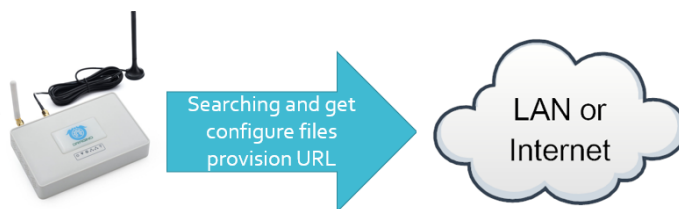

1. Gateways search (on every boot or 23:00 every day) the provision URL to get configure files or script files.
2. Gateways compare version number of the configure file, and process update if configure files has higher version.

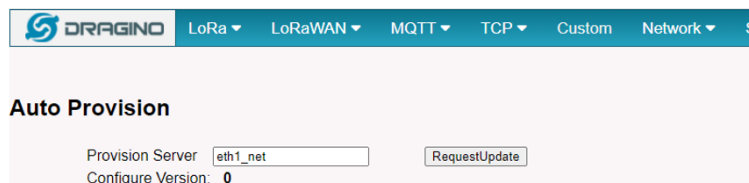

Please see this document for detail:

[http://www.dragino.com/downloads/index.php?dir=LoRa\\_Gateway/LPS8/Firmware/Application\\_Note/&file=Auto-update-feature.pdf](http://www.dragino.com/downloads/index.php?dir=LoRa_Gateway/LPS8/Firmware/Application_Note/&file=Auto-update-feature.pdf)

R-SSH is for remote access device and management, introduction for how to use:

[http://wiki.dragino.com/index.php?title=Main\\_Page#Remote\\_Access\\_Gateway\\_via\\_Reverse\\_SSH](http://wiki.dragino.com/index.php?title=Main_Page#Remote_Access_Gateway_via_Reverse_SSH)

### R-SSH Host Settings

Login ID

Host Address  Host Port

Connect at Startup  GWID: a84041ffff1d25dc

Connection Status: **Not connected to RSSH Host**

Note: Auto connection after startup may take up to 5 minutes to clear previous connection

### Generate New Keys

Current Key ID: **No keyfile present**

**Caution: Generating new keys will break any existing server connections!!**

[Download Public Key](#)

## 5.5.7 System --> Firmware Upgrade

We keep improving the LIG16 firmware for new features and bug fixes. Below are the links for reference.

- **Latest firmware:** [LoRa Gateway Firmware](http://www.dragino.com/downloads/index.php?dir=LoRa_Gateway/LIG16/Firmware),  
( [http://www.dragino.com/downloads/index.php?dir=LoRa\\_Gateway/LIG16/Firmware](http://www.dragino.com/downloads/index.php?dir=LoRa_Gateway/LIG16/Firmware) )
- **Change Log:** [Firmware Change Log](http://www.dragino.com/downloads/downloads/LoRa_Gateway/LIG16/Firmware/ChangeLog).  
( [http://www.dragino.com/downloads/downloads/LoRa\\_Gateway/LIG16/Firmware/ChangeLog](http://www.dragino.com/downloads/downloads/LoRa_Gateway/LIG16/Firmware/ChangeLog) )

The file named as **dragino-lgw-xxxxx-squashfs-sysupgrade.bin** is the upgrade Image. as below.

[Web](#) → [System](#) → [Firmware Upgrade](#)

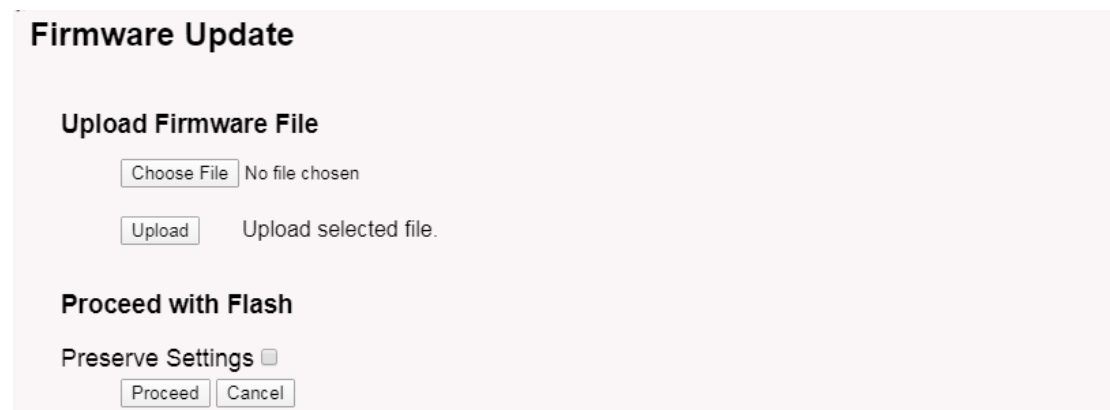

The screenshot shows a web interface titled "Firmware Update". It contains two main sections: "Upload Firmware File" and "Proceed with Flash".

**Upload Firmware File**

Choose File No file chosen

Upload Upload selected file.

**Proceed with Flash**

Preserve Settings

Proceed Cancel

Select the required image and click **Upload**. The image will be uploaded to the device, and then click **Process** to upgrade.

**NOTE:** You normally need to **uncheck** the **Preserve Settings** checkbox when doing an upgrade to ensure that there is no conflict between the old settings and the new firmware. The new firmware will start up with its default settings.

The system will automatically boot into the new firmware after upgrade.

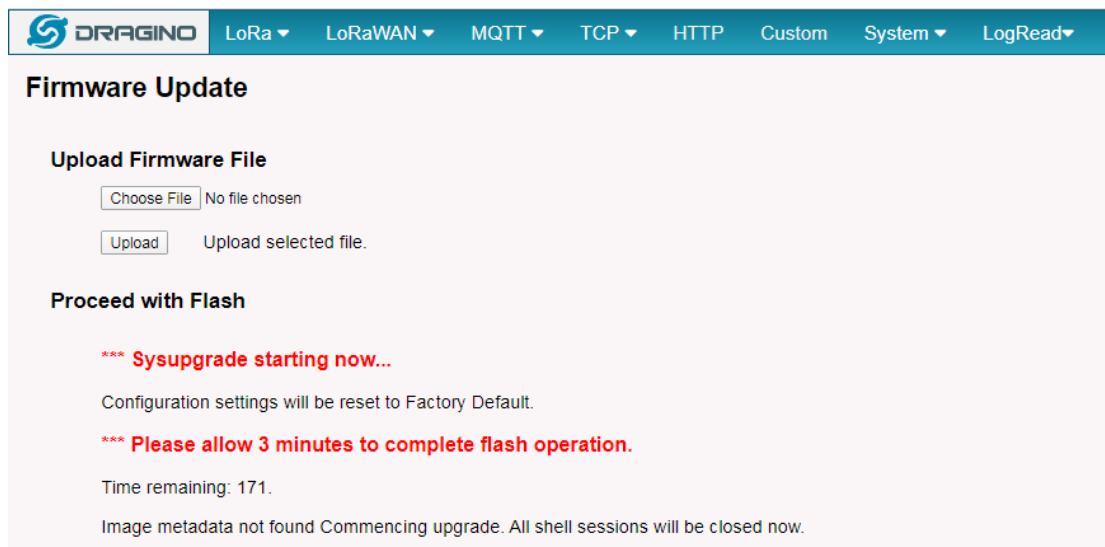

Note \*: User can also upgrade firmware via Linux console  
SCP the firmware to the system **/var** directory and then run

```
root@OpenWrt:~# /sbin/sysupgrade -n /var/Your_Image
```

**NOTE:** it is important to transfer the image in the /var directory, otherwise it may exceed the available flash size.

### 5.5.8 System --> Reboot/Reset

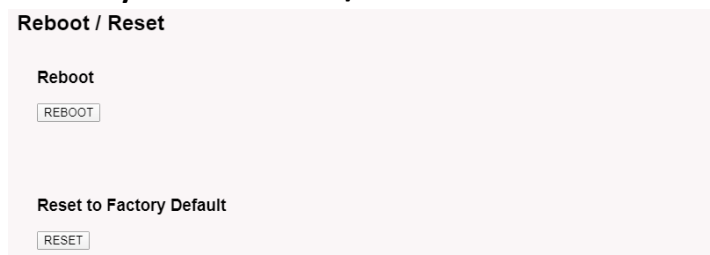



## 5.5.9 System --> Package Maintain

**Package Management**

**Package List**

Package data is not loaded. Click on Reload to download package data.

Click Reload to download package list. This will take a while.

**Installed Package List**

```
atftp - 0.7.1-5
base-files - 190-r5-ce45a50
blkid - 2.32.2
block-mount - 2018-04-16-e2436836-1
busybox - 1.28.3-4
ca-certificates - 20180409
chat - 2.4.7-12
```

Place to show what packages have been installed and possible to upgrade packages.

## 5.6 LogRead

### 5.6.1 LogRead --> LoRa Log

#### LogRead

**FreqINFO:**

SX1301 Channels frequency

-----

chan\_multSF\_0  
Lora MAC, 125kHz, all SF, 868.1 MHz

-----

chan\_multSF\_1  
Lora MAC, 125kHz, all SF, 868.3 MHz

-----

chan\_multSF\_2  
Lora MAC, 125kHz, all SF, 868.5 MHz

-----

chan\_multSF\_3  
Lora MAC, 125kHz, all SF, 867.1 MHz

-----

chan\_multSF\_4  
Lora MAC, 125kHz, all SF, 867.3 MHz

-----

chan\_multSF\_5  
Lora MAC, 125kHz, all SF, 867.5 MHz

-----

chan\_multSF\_6

Show the frequency for LoRa Radio and traffics.

### 5.6.2 LogRead --> Gateway Traffic

Shows gateway traffic statistics in the past 72 hours and the last 100 gateway traffic entries.

DRAGINO

[LoRa](#)
[LoRaWAN](#)
[MQTT](#)
[TCP](#)
[Custom](#)
[Network](#)
[System](#)
[LogRead](#)
[Home](#)
[Logout](#)

#### Gateway Traffic

Total: 12693; Up: 12669; Down: 20

○ Uplink    ○ Downlink

Time	Message Type	Mod	Freq	Data Rate	CNT	Content
01/03-10:53:44	Data Unconfirmed Up	LoRa	868.3	SF12 BW125	1820	Dev Addr: 26011D43, Size: 24
01/03-10:53:21	Data Unconfirmed Up	LoRa	868.3	SF12 BW125	1819	Dev Addr: 26011D43, Size: 24
01/03-10:52:59	Data Unconfirmed Up	LoRa	868.5	SF12 BW125	1818	Dev Addr: 26011D43, Size: 24
01/03-10:52:47	Data Unconfirmed Up	LoRa	868.5	SF7 BW125	24742	Dev Addr: 26013789, Size: 24
01/03-10:52:36	Data Unconfirmed Up	LoRa	868.1	SF12 BW125	1817	Dev Addr: 26011D43, Size: 24
01/03-10:52:13	Data Unconfirmed Up	LoRa	868.5	SF12 BW125	1816	Dev Addr: 26011D43, Size: 24

### 5.6.3 LogRead --> System Log

Show the system log

## System Log

### USB Devices:

```
Bus 001 Device 003: ID 0403:6001 Future Technology Devices International, Ltd FT232 Serial (UART) IC
Bus 001 Device 002: ID 1a40:0101 Terminus Technology Inc. Hub
Bus 001 Device 001: ID 1d6b:0002 Linux Foundation 2.0 root hub
```

### Boot Info:

```
Linux version 4.9.109 (root@DraginoHK) (gcc version 7.3.0 (OpenWrt GCC 7.3.0 r7360-e15565a) ) #0 Fri Jun 29 16:58:53 2018
MyLoader: syp=aaaaaaaa, boardp=2aabaaab, parts=aaaa2aab
bootconsole [early0] enabled
CPU0 revision is: 00019374 (MIPS 24Kc)
SoC: Atheros AR9330 rev 1
Determined physical RAM map:
memory: 04000000 @ 00000000 (usable)
initrd not found or empty - disabling initrd
Primary instruction cache 64kB, VIPT, 4-way, linesize 32 bytes.
Primary data cache 32kB, 4-way, VIPT, cache aliases, linesize 32 bytes
```

### Previous Log:

## 6. More features

### 6.1 More instructions

[http://wiki.dragino.com/index.php?title=Main\\_Page#LoRa.2FLoRaWAN\\_Gateway\\_Instruction](http://wiki.dragino.com/index.php?title=Main_Page#LoRa.2FLoRaWAN_Gateway_Instruction)

## 7. Linux System

The LIG16 bases on OpenWrt Linux System. It is open source, and user are free to configure and modify the inside Linux settings.

### 7.1 SSH Access for Linux console

User can access to the Linux console via SSH protocol. Make sure your PC and the LIG16 is in the same network, then use a SSH tool (such as [putty](#)) to access it. Below are screenshots:

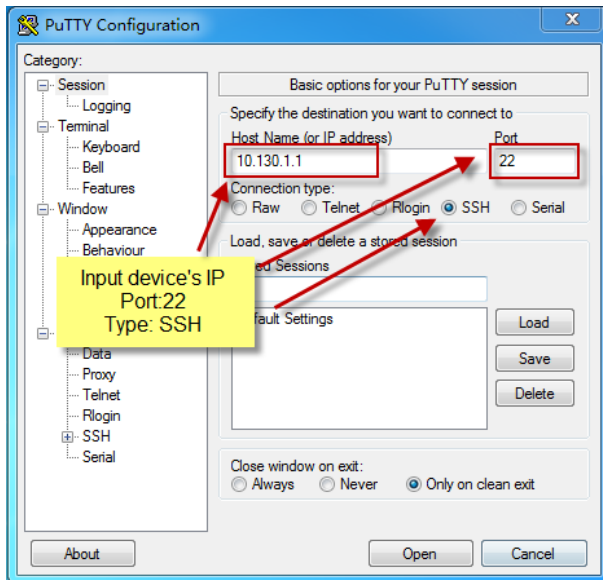

IP address: IP address of LIG16  
 Port: 22 or 2222  
 User Name: **root**  
 Password: **dragino** (default)

After log in, you will be in the Linux console and type command here.

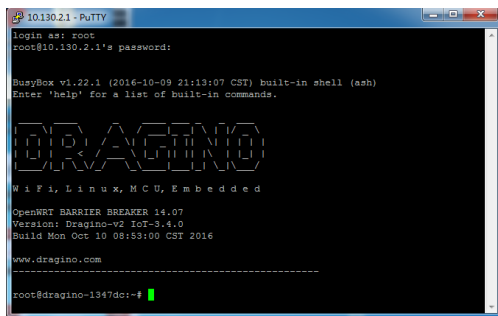

The "logread -f" command can be used to debug how system runs.

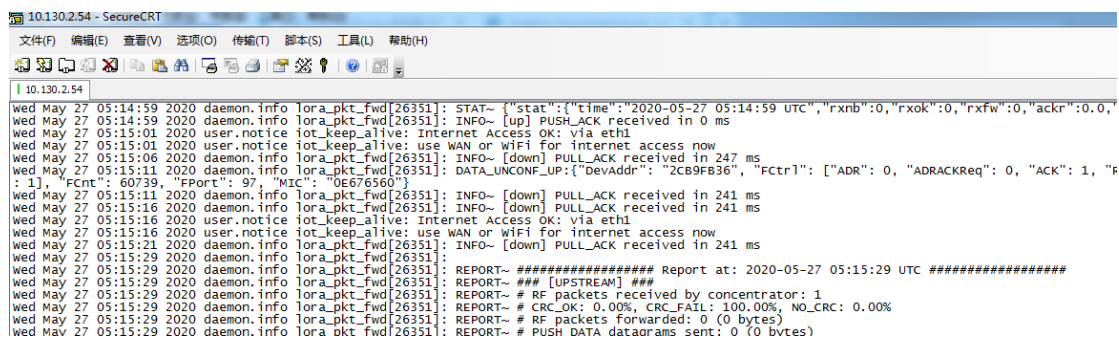

## 7.2 Edit and Transfer files

The LIG16 support **SCP protocol** and has a built **SFTP server**. There are many ways to edit and transfer files using these two protocols. One of the easiest is through [WinSCP](#) utility. After access via WinSCP to the device, use can use a FTP alike window to drag / drop files to the LIG16 or Edit the files directly in the windows. Screenshot is as below:

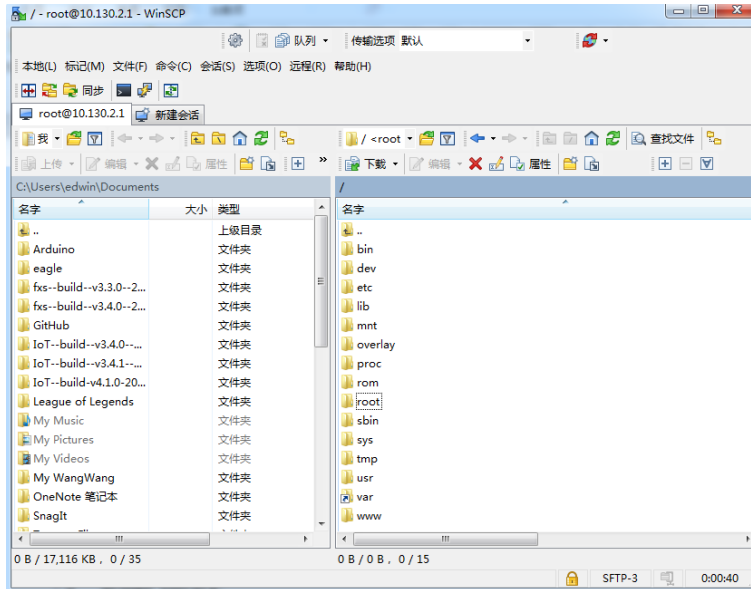

## 7.3 File System

The LIG16 has a 16MB flash and a 64MB RAM. The /var and /tmp directory are in the RAM, contents stored in /tmp and /var will be erased after reboot the device. Other directories are in the flash and will keep after reboot.

The Linux system use around 8MB ~10MB flash size which means there is not much room for user to store data in the LIG16 flash. User can use an external USB flash to extend the size for storage.

## 7.4 Package maintain system

LIG16 uses [OPKG package maintain system](#). There are more than 3000+ packages available in our package server for user to install for their applications. For example, if user wants to add iperf tool, they can install the related packages and configure LIG16 to use iperf

Below is some examples opkgs command, more please refer [OPKG package maintain system](#)

In Linux Console run:

```
root@dragino-169d30:~# opkg update // to get the latest packages list
```

```
root@dragino-169d30:~# opkg list //shows the available packages
```

```
root@dragino-169d30:~# opkg install iperf // install iperf, it will auto install the required packages.
```

```
root@dragino-169d30:/etc/opkg# opkg install iperf
```

```
Installing iperf (2.0.12-1) to root...
```

```
Downloading http://downloads.openwrt.org/snapshots/packages/mips_24kc/base/iperf_2.0.12-1_mips_24kc.ipk
```

```
Installing uclibcxx (0.2.4-3) to root...
```

```
Downloading
```

```
http://downloads.openwrt.org/snapshots/packages/mips_24kc/base/uclibcxx_0.2.4-3_mips_24kc.ipk
```

```
Configuring uclibcxx.
```

```
Configuring iperf.
```

## 8. FAQ

### 8.1 How can I configure for a customized frequency band?

See below link for how to customize frequency band:

[http://wiki.dragino.com/index.php?title=Customized Frequency Band for Gateway](http://wiki.dragino.com/index.php?title=Customized_Frequency_Band_for_Gateway)

### 8.2 Can I make my own firmware for the gateway, where can I find the source code?

Yes, you can make your own firmware for the LIG16 for branding purposes or to add customized applications.

The source code and compile instructions can be found at:

[https://github.com/dragino/openwrt\\_lede-18.06](https://github.com/dragino/openwrt_lede-18.06)

### 8.3 Can I use 868Mhz version for 915Mhz bands?

It is possible but the distance will be very short, you can select US915 frequency band in 868Mhz version hardware. It will work but you will see the performance is greatly decreased because the 868Mhz version has an RF filter for band 863~870Mhz, all other frequencies will have high attenuation.

### 8.4 Can I control the triangle LED?

First export the gpio22(triangle LED) and set to out

```
echo 22 > /sys/class/gpio/export
```

```
echo out > /sys/class/gpio/gpio22/direction
```

```
ON: echo 0 > /sys/class/gpio/gpio22/value
```

```
OFF: echo 1 > /sys/class/gpio/gpio22/value
```

## 9. Trouble Shooting

### 9.1 I get kernel error when install new package, how to fix?

In some case, when install package, it will generate kernel error such as below:

```
root@dragino-16c538:~# opkg install kmod-dragino2-si3217x_3.10.49+0.2-1_ar71xx.ipk
```

```
Installing kmod-dragino2-si3217x (3.10.49+0.2-1) to root...
```

```
Collected errors:
```

```
* satisfy_dependencies_for: Cannot satisfy the following dependencies for
```

```
kmod-dragino2-si3217x:
```

```
* kernel (= 3.10.49-1-4917516478a753314254643facdf360a) *
```

```
* opkg_install_cmd: Cannot install package kmod-dragino2-si3217x.
```



In this case, user can use the `--force-depends` option to install such package.

```
opkg install kmod-dragino2-si3217x_3.10.49+0.2-1_ar71xx.ipk --force-depends
```

### 9.2 How to recover the LIG16 if firmware crash

Please follow this instruction to recover your gateway:

[http://wiki.dragino.com/index.php?title=Recover\\_Gateway](http://wiki.dragino.com/index.php?title=Recover_Gateway)

### 9.3 I configured LIG16 for WiFi access and lost its IP. What to do now?

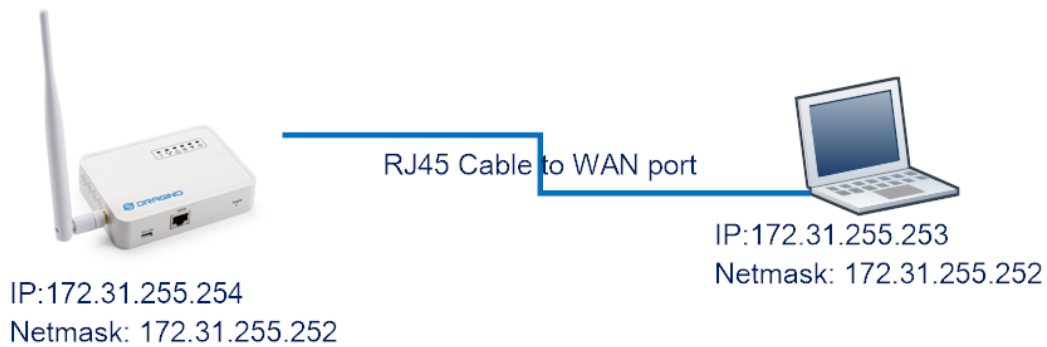

The LIG16 has a fallback ip in its WAN port. This IP is always enabled so user can use fall back ip to access LIG16 no matter what the WiFi IP is. The fall back ip is useful for connect and debug the unit.

(Note: fallback ip can be disabled in the LAN and DHCP page)

Steps to connect via fall back IP:

1. Connect PC's Ethernet port to LIG16's WAN port
2. Configure PC's Ethernet port has IP: 172.31.255.253 and netmask: 255.255.255.252

As below photo:

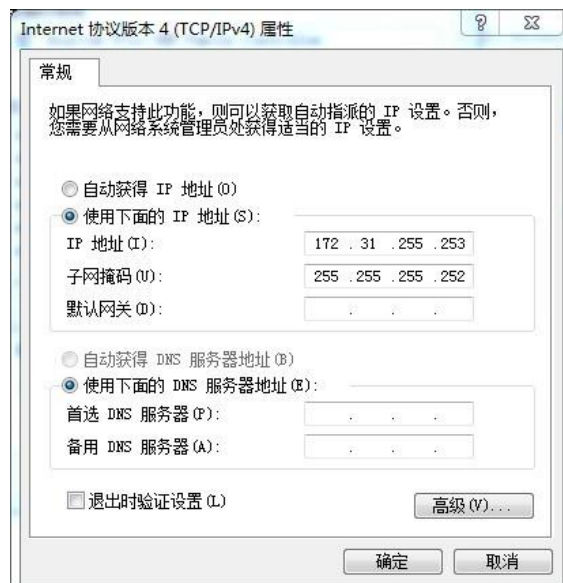

3. In PC, use 172.31.255.254 to access LIG16 via Web or Console.

## 10. Order Info

### **PART: LIG16-XXX:**

#### **XXX: Frequency Band**

- **868**: valid frequency: 863Mhz ~ 870Mhz. for band EU868 or IN865.
- **915**: valid frequency: 902Mhz ~ 928Mhz. for bands US915, AU915, AS923 or KR920

## 11. Packing Info

### **Package Includes:**

- ✓ LIG16 LoRaWAN Indoor Gateway x 1
- ✓ Stick Antenna for LoRa RF part. Frequency is one of 433 or 868 or 915Mhz depends the model ordered
- ✓ Power Adapter: EU/AU/US type power adapter depends on country to be used
- ✓ Packaging with environmental protection paper box

### **Dimension and weight:**

- ✓ Device Size: 12 x 8.5 x 3 cm
- ✓ Device Weight: 150g
- ✓ Package Size / pcs : 21.5 x 10 x 5 cm
- ✓ Weight / pcs : 360g
- ✓ Carton dimension: 45 x 31 x 34 cm. 36pcs per carton
- ✓ Weight / carton : 12.5 kg

## 12. Support

- Try to see if your questions already answered in the [wiki](#).
- Support is provided Monday to Friday, from 09:00 to 18:00 GMT+8. Due to different timezones we cannot offer live support. However, your questions will be answered as soon as possible in the before-mentioned schedule.
- Provide as much information as possible regarding your enquiry (product models, accurately describe your problem and steps to replicate it etc) and send a mail to

[support@dragino.com](mailto:support@dragino.com)