

List of Attachments (including a total number of pages in each attachment):

Attachment No. 1: EUROPEAN GROUP DIFFERENCES AND NATIONAL DIFFERENCES for EN 62368-1:2014+A11:2017

Attachment No. 2: Photos.

Summary of testing:

Tests performed (name of test and test clause):

The submitted samples were tested and found to comply with the requirements of:

- EN 62368-1:2014/A11:2017

Testing location:

Global United Technology Services Co., Ltd.
No.123-128, Tower A, Jinyuan Business Building, No. 2, Laodong Industrial Zone, Xixiang Road, Baoan District, Shenzhen, Guangdong, China

Summary of compliance with National Differences:

List of countries addressed: See the attachment No. 1 of National and Group Differences for details.

The product fulfils the requirements of EN 62368-1:2014/A11:2017.

Copy of marking plate:

The artwork below may be only a draft. The use of certification marks on a product must be authorized by the respective Certification Bodies that own these marks.



Remark: The height of CE symbols is more than 5 mm, the height of WEEE symbols is more than 7 mm;

TEST ITEM PARTICULARS:	
Classification of use by	<input checked="" type="checkbox"/> Ordinary person <input checked="" type="checkbox"/> Instructed person <input checked="" type="checkbox"/> Skilled person <input checked="" type="checkbox"/> Children likely to be present
Supply Connection.....	<input type="checkbox"/> AC Mains <input type="checkbox"/> DC Mains <input checked="" type="checkbox"/> External Circuit - not Mains connected - <input checked="" type="checkbox"/> ES1 <input type="checkbox"/> ES2 <input type="checkbox"/> ES3
Supply % Tolerance	<input type="checkbox"/> +10%/-10% <input type="checkbox"/> +20%/-15% <input type="checkbox"/> +25%/-15% <input checked="" type="checkbox"/> None
Supply Connection – Type	<input type="checkbox"/> pluggable equipment type A - <input type="checkbox"/> non-detachable supply cord <input type="checkbox"/> appliance coupler <input type="checkbox"/> direct plug-in <input type="checkbox"/> mating connector <input type="checkbox"/> pluggable equipment type B - <input type="checkbox"/> non-detachable supply cord <input type="checkbox"/> appliance coupler <input type="checkbox"/> permanent connection <input type="checkbox"/> mating connector <input checked="" type="checkbox"/> other: <u>powered by battery</u>
Considered current rating of protective device as part of building or equipment installation	N/A (Not directly connected to mains) Installation location: <input type="checkbox"/> building; <input type="checkbox"/> equipment
Equipment mobility	<input checked="" type="checkbox"/> movable <input type="checkbox"/> hand-held <input checked="" type="checkbox"/> transportable <input type="checkbox"/> stationary <input type="checkbox"/> for building-in <input type="checkbox"/> direct plug-in <input type="checkbox"/> rack-mounting <input type="checkbox"/> wall-mounted
Over voltage category (OVC)	<input type="checkbox"/> OVC I <input type="checkbox"/> OVC II <input type="checkbox"/> OVC III <input type="checkbox"/> OVC IV <input checked="" type="checkbox"/> other: --(Not directly connected to mains)
Class of equipment	<input type="checkbox"/> Class I <input type="checkbox"/> Class II <input checked="" type="checkbox"/> Class III
Access location	<input type="checkbox"/> restricted access location <input checked="" type="checkbox"/> N/A
Pollution degree (PD)	<input type="checkbox"/> PD 1 <input checked="" type="checkbox"/> PD 2 <input type="checkbox"/> PD 3
Manufacturer's specified maximum operating ambient:	<u>40</u> °C
IP protection class	<input checked="" type="checkbox"/> IP20 <input type="checkbox"/> IP__
Power Systems	<input type="checkbox"/> TN <input type="checkbox"/> TT <input type="checkbox"/> IT - <u>230</u> V _{L-L}
Altitude during operation (m)	<input checked="" type="checkbox"/> 2000 m or less <input type="checkbox"/> <u>5000</u> m
Altitude of test laboratory (m)	<input type="checkbox"/> 2000 m or less <input checked="" type="checkbox"/> <u>500</u> m
Mass of equipment (kg)	<input checked="" type="checkbox"/> approx. 0.12 kg
POSSIBLE TEST CASE VERDICTS:	
- test case does not apply to the test object.....	N/A
- test object does meet the requirement	P (Pass)

- test object does not meet the requirement	F (Fail)
TESTING:	
Date of receipt of test item.....	2020-05-14
Date (s) of performance of tests	2020-05-14 to 2020-05-21
The application for obtaining a CB Test Certificate includes more than one factory location and a declaration from the Manufacturer stating that the sample(s) submitted for evaluation is (are) representative of the products from each factory has been provided	<input checked="" type="checkbox"/> Yes <input type="checkbox"/> Not applicable
When differences exist; they shall be identified in the General product information section.	
Name and address of factory (ies)	Same as applicant
GENERAL PRODUCT INFORMATION:	
Product Description –	
1. LoRaWAN Sensor Node, model LSN50 v2, powered by non-rechargeable Li/SOCl ₂ battery; 2. The internal non-rechargeable Li/SOCl ₂ battery was certificated.	
Model Differences –	
Additional application considerations – (Considerations used to test a component or sub-assembly) –	
- The maximum operating temperature is 40°C.	

ENERGY SOURCE IDENTIFICATION AND CLASSIFICATION TABLE:	
<p>(Note 1: Identify the following six (6) energy source forms based on the origin of the energy.) (Note 2: The identified classification e.g., ES2, TS1, should be with respect to its ability to cause pain or injury on the body or its ability to ignite a combustible material. Any energy source can be declared Class 3 as a worse case classification e.g. PS3, ES3.)</p>	
<p>Electrically-caused injury (Clause 5): (Note: Identify type of source, list sub-assembly or circuit designation and corresponding energy source classification) Example: +5 V dc input</p>	
	ES1
Source of electrical energy	Corresponding classification (ES)
All internal circuits	ES1
<p>Electrically-caused fire (Clause 6): (Note: List sub-assembly or circuit designation and corresponding energy source classification) Example: Battery pack (maximum 85 watts):</p>	
	PS2
Source of power or PIS	Corresponding classification (PS)
Internal circuits	PS1
Internal battery	PS1
<p>Injury caused by hazardous substances (Clause 7) (Note: Specify hazardous chemicals, whether produces ozone or other chemical construction not addressed as part of the component evaluation.) Example: Liquid in filled component</p>	
	Glycol
Source of hazardous substances	Corresponding chemical
-	-
<p>Mechanically-caused injury (Clause 8) (Note: List moving part(s), fan, special installations, etc. & corresponding MS classification based on Table 35.) Example: Wall mount unit</p>	
	MS2
Source of kinetic/mechanical energy	Corresponding classification (MS)
Sharp edges and corners of accessible parts	MS1
Product mass	MS1
<p>Thermal burn injury (Clause 9) (Note: Identify the surface or support, and corresponding energy source classification based on type of part, location, operating temperature and contact time in Table 38.) Example: Hand-held scanner – thermoplastic enclosure</p>	
	TS1
Source of thermal energy	Corresponding classification (TS)
Accessible parts	TS1
<p>Radiation (Clause 10) (Note: List the types of radiation present in the product and the corresponding energy source classification.) Example: DVD – Class 1 Laser Product</p>	
	RS1
Type of radiation	Corresponding classification (RS)
N/A (LED indicator light)	N/A

ENERGY SOURCE DIAGRAM

Indicate which energy sources are included in the energy source diagram. Insert diagram below

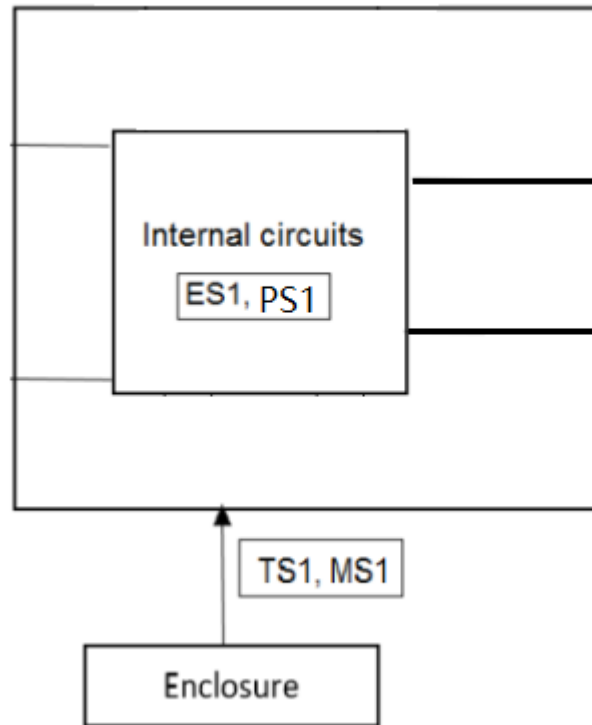

ES PS MS TS RS

Remark: N/A

OVERVIEW OF EMPLOYED SAFEGUARDS				
Clause	Possible Hazard			
5.1	Electrically-caused injury			
Body Part (e.g. Ordinary)	Energy Source (ES3: Primary Filter circuit)	Safeguards		
		Basic	Supplementary	Reinforced (Enclosure)
Ordinary person, Skilled person	ES1: Internal circuits	N/A	N/A	N/A
6.1	Electrically-caused fire			
Material part (e.g. mouse enclosure)	Energy Source (PS2: 100 Watt circuit)	Safeguards		
		Basic	Supplementary	Reinforced
Internal combustible material/ internal plastic enclosure	PS1: Internal circuits PS1: battery	N/A	PCB: V-0	Enclosure: V-0
7.1	Injury caused by hazardous substances			
Body Part (e.g., skilled)	Energy Source (hazardous material)	Safeguards		
		Basic	Supplementary	Reinforced
-	-	-	-	-
8.1	Mechanically-caused injury			
Body Part (e.g. Ordinary)	Energy Source (MS3: High Pressure Lamp)	Safeguards		
		Basic	Supplementary	Reinforced (Enclosure)
Ordinary person, Skilled person	MS1: Sharp edges and corners of accessible parts	N/A	N/A	N/A
Ordinary person, Skilled person	MS1: Product mass	N/A	N/A	N/A
9.1	Thermal Burn			
Body Part (e.g., Ordinary)	Energy Source (TS2)	Safeguards		
		Basic	Supplementary	Reinforced
Ordinary person, Skilled person	TS1: Accessible parts	N/A	N/A	N/A
10.1	Radiation			
Body Part (e.g., Ordinary)	Energy Source (Output from audio port)	Safeguards		
		Basic	Supplementary	Reinforced
-	-	-	-	-
Supplementary Information:				
(1) See attached energy source diagram for additional details.				
(2) "N" – Normal Condition; "A" – Abnormal Condition; "S" Single Fault.				

IEC 62368-1			
Clause	Requirement + Test	Result - Remark	Verdict

4	GENERAL REQUIREMENTS		P
4.1.1	Acceptance of materials, components and subassemblies		P
4.1.2	Use of components	(See appended table 4.1.2)	P
4.1.3	Equipment design and construction		P
4.1.15	Markings and instructions.....:	(See Annex F)	P
4.4.4	Safeguard robustness		P
4.4.4.2	Steady force tests.....:	(See Annex T.5)	P
4.4.4.3	Drop tests	(See Annex T.7)	P
4.4.4.4	Impact tests		N/A
4.4.4.5	Internal accessible safeguard enclosure and barrier tests.....:	No such enclosure and barrier	N/A
4.4.4.6	Glass Impact tests	No glass used	N/A
4.4.4.7	Thermoplastic material tests	(See Annex T.8)	N/A
4.4.4.8	Air comprising a safeguard.....:	Considered, but no such barrier or enclosure provided	N/A
4.4.4.9	Accessibility and safeguard effectiveness	All safeguards remain effective	P
4.5	Explosion		P
4.6	Fixing of conductors		P
4.6.1	Fix conductors not to defeat a safeguard		P
4.6.2	10 N force test applied to		P
4.7	Equipment for direct insertion into mains socket - outlets	No such apparatus	N/A
4.7.2	Mains plug part complies with the relevant standard.....:		N/A
4.7.3	Torque (Nm)		N/A
4.8	Products containing coin/button cell batteries	No coin/button cell batteries used	N/A
4.8.2	Instructional safeguard		N/A
4.8.3	Battery Compartment Construction		N/A
	Means to reduce the possibility of children removing the battery		—
4.8.4	Battery Compartment Mechanical Tests		N/A
4.8.5	Battery Accessibility		N/A
4.9	Likelihood of fire or shock due to entry of conductive object.....:	(See Annex P)	P

5	ELECTRICALLY-CAUSED INJURY		P
5.2.1	Electrical energy source classifications.....:	(See appended table 5.2)	P

IEC 62368-1			
Clause	Requirement + Test	Result - Remark	Verdict
5.2.2	ES1, ES2 and ES3 limits		P
5.2.2.2	Steady-state voltage and current..... :	(See appended table 5.2)	P
5.2.2.3	Capacitance limits :		N/A
5.2.2.4	Single pulse limits :	No single pulse introduced	N/A
5.2.2.5	Limits for repetitive pulses :	No repetitive pulses introduced	N/A
5.2.2.6	Ringling signals :	No means for connection to telephone network and no ringing signal generated	N/A
5.2.2.7	Audio signals :	(See appended table 5.2)	N/A
5.3	Protection against electrical energy sources	All internal circuits considered ES1	N/A
5.3.1	General Requirements for accessible parts to ordinary, instructed and skilled persons		N/A
5.3.2.1	Accessibility to electrical energy sources and safeguards		N/A
5.3.2.2	Contact requirements		N/A
	a) Test with test probe from Annex V :		N/A
	b) Electric strength test potential (V) :		N/A
	c) Air gap (mm) :		N/A
5.3.2.4	Terminals for connecting stripped wire		N/A
5.4	Insulation materials and requirements		N/A
5.4.1.2	Properties of insulating material		N/A
5.4.1.3	Humidity conditioning :		N/A
5.4.1.4	Maximum operating temperature for insulating materials :		N/A
5.4.1.5	Pollution degree :		—
5.4.1.5.2	Test for pollution degree 1 environment and for an insulating compound		N/A
5.4.1.5.3	Thermal cycling		N/A
5.4.1.6	Insulation in transformers with varying dimensions		N/A
5.4.1.7	Insulation in circuits generating starting pulses		N/A
5.4.1.8	Determination of working voltage		N/A
5.4.1.9	Insulating surfaces		N/A
5.4.1.10	Thermoplastic parts on which conductive metallic parts are directly mounted		N/A
5.4.1.10.2	Vicat softening temperature..... :		N/A
5.4.1.10.3	Ball pressure :		N/A
5.4.2	Clearances		N/A
5.4.2.2	Determining clearance using peak working voltage		N/A

IEC 62368-1			
Clause	Requirement + Test	Result - Remark	Verdict
5.4.2.3	Determining clearance using required withstand voltage		N/A
	a) a.c. mains transient voltage		—
	b) d.c. mains transient voltage		—
	c) external circuit transient voltage		—
	d) transient voltage determined by measurement:		—
5.4.2.4	Determining the adequacy of a clearance using an electric strength test		N/A
5.4.2.5	Multiplication factors for clearances and test voltages	The multiplication factor for altitude up to 2000m is 1.0	N/A
5.4.3	Creepage distances	(See appended table 5.4.3)	N/A
5.4.3.1	General		N/A
5.4.3.3	Material Group	Assume to group IIIb	—
5.4.4	Solid insulation		N/A
5.4.4.2	Minimum distance through insulation		N/A
5.4.4.3	Insulation compound forming solid insulation		N/A
5.4.4.4	Solid insulation in semiconductor devices		N/A
5.4.4.5	Cemented joints		N/A
5.4.4.6	Thin sheet material		N/A
5.4.4.6.1	General requirements		N/A
5.4.4.6.2	Separable thin sheet material		N/A
	Number of layers (pcs)		N/A
5.4.4.6.3	Non-separable thin sheet material		N/A
5.4.4.6.4	Standard test procedure for non-separable thin sheet material		N/A
5.4.4.6.5	Mandrel test		N/A
5.4.4.7	Solid insulation in wound components		N/A
5.4.4.9	Solid insulation at frequencies >30 kHz		N/A
5.4.5	Antenna terminal insulation	No such terminal	N/A
5.4.5.1	General		N/A
5.4.5.2	Voltage surge test		N/A
	Insulation resistance (MΩ).....		—
5.4.6	Insulation of internal wire as part of supplementary safeguard.....		N/A
5.4.7	Tests for semiconductor components and for cemented joints		N/A
5.4.8	Humidity conditioning		N/A
	Relative humidity (%).....		—

IEC 62368-1			
Clause	Requirement + Test	Result - Remark	Verdict
	Temperature (°C)		—
	Duration (h)		—
5.4.9	Electric strength test		N/A
5.4.9.1	Test procedure for a solid insulation type test		N/A
5.4.9.2	Test procedure for routine tests		N/A
5.4.10	Protection against transient voltages between external circuit	No transient voltage from external circuit	N/A
5.4.10.1	Parts and circuits separated from external circuits		N/A
5.4.10.2	Test methods		N/A
5.4.10.2.1	General		N/A
5.4.10.2.2	Impulse test		N/A
5.4.10.2.3	Steady-state test.....		N/A
5.4.11	Insulation between external circuits and earthed circuitry	No such external circuit	N/A
5.4.11.1	Exceptions to separation between external circuits and earth		N/A
5.4.11.2	Requirements		N/A
	Rated operating voltage U_{op} (V).....		—
	Nominal voltage U_{peak} (V).....		—
	Max increase due to variation U_{sp}		—
	Max increase due to ageing ΔU_{sa}		—
	$U_{op} = U_{peak} + \Delta U_{sp} + \Delta U_{sa}$		—
5.5	Components as safeguards		
5.5.1	General		N/A
5.5.2	Capacitors and RC units		N/A
5.5.2.1	General requirement		N/A
5.5.2.2	Safeguards against capacitor discharge after disconnection of a connector.....		N/A
5.5.3	Transformers		N/A
5.5.4	Optocouplers		N/A
5.5.5	Relays		N/A
5.5.6	Resistors		N/A
5.5.7	SPD's		N/A
5.5.7.1	Use of an SPD connected to reliable earthing		N/A
5.5.7.2	Use of an SPD between mains and protective earth		N/A
5.5.8	Insulation between the mains and external circuit consisting of a coaxial cable.....		N/A

IEC 62368-1			
Clause	Requirement + Test	Result - Remark	Verdict
5.6	Protective conductor		N/A
5.6.2	Requirement for protective conductors		N/A
5.6.2.1	General requirements		N/A
5.6.2.2	Colour of insulation		N/A
5.6.3	Requirement for protective earthing conductors		N/A
	Protective earthing conductor size (mm ²)		—
5.6.4	Requirement for protective bonding conductors		N/A
5.6.4.1	Protective bonding conductors		N/A
	Protective bonding conductor size (mm ²).....		—
5.6.4.2	Protective current rating (A)		—
5.6.4.3	Current limiting and overcurrent protective devices		N/A
5.6.5	Terminals for protective conductors		N/A
5.6.5.1	Requirement		N/A
	Conductor size (mm ²), nominal thread diameter (mm)		N/A
5.6.5.2	Corrosion		N/A
5.6.6	Resistance of the protective system		N/A
5.6.6.1	Requirements		N/A
5.6.6.2	Test Method Resistance (Ω).....		N/A
5.6.7	Reliable earthing		N/A
5.7	Prospective touch voltage, touch current and protective conductor current		N/A
5.7.2	Measuring devices and networks		N/A
5.7.2.1	Measurement of touch current		N/A
5.7.2.2	Measurement of prospective touch voltage		N/A
5.7.3	Equipment set-up, supply connections and earth connections		N/A
	System of interconnected equipment (separate connections/single connection)		—
	Multiple connections to mains (one connection at a time/simultaneous connections)		—
5.7.4	Earthed conductive accessible parts.....		N/A
5.7.5	Protective conductor current		N/A
	Supply Voltage (V).....		—
	Measured current (mA).....		—
	Instructional Safeguard.....		N/A
5.7.6	Prospective touch voltage and touch current due to external circuits		N/A

IEC 62368-1			
Clause	Requirement + Test	Result - Remark	Verdict
5.7.6.1	Touch current from coaxial cables		N/A
5.7.6.2	Prospective touch voltage and touch current from external circuits		N/A
5.7.7	Summation of touch currents from external circuits	No such external circuits	N/A
	a) Equipment with earthed external circuits Measured current (mA).....:		N/A
	b) Equipment whose external circuits are not referenced to earth. Measured current (mA).....:		N/A

6	ELECTRICALLY- CAUSED FIRE		P
6.2	Classification of power sources (PS) and potential ignition sources (PIS)		P
6.2.2	Power source circuit classifications		P
6.2.2.1	General		P
6.2.2.2	Power measurement for worst-case load fault ... :	(See appended table 6.2.2)	P
6.2.2.3	Power measurement for worst-case power source fault.....:	(See appended table 6.2.2)	P
6.2.2.4	PS1		P
6.2.2.5	PS2	(See appended table 6.2.2)	N/A
6.2.2.6	PS3		N/A
6.2.3	Classification of potential ignition sources		N/A
6.2.3.1	Arcing PIS		N/A
6.2.3.2	Resistive PIS	(See appended table 6.2.3.2)	N/A
6.3	Safeguards against fire under normal operating and abnormal operating conditions		P
6.3.1 (a)	No ignition and attainable temperature value less than 90 % defined by ISO 871 or less than 300 °C for unknown materials.....:	(See appended table 5.4.1.5, 6.3.2, 9.0, B.2.6)	P
6.3.1 (b)	Combustible materials outside fire enclosure		N/A
6.4	Safeguards against fire under single fault conditions		P
6.4.1	Safeguard Method		P
6.4.2	Reduction of the likelihood of ignition under single fault conditions in PS1 circuits		P
6.4.3	Reduction of the likelihood of ignition under single fault conditions in PS2 and PS3 circuits		N/A
6.4.3.1	General		N/A
6.4.3.2	Supplementary Safeguards		N/A
	Special conditions if conductors on printed boards are opened or peeled		N/A
6.4.3.3	Single Fault Conditions.....:		N/A
	Special conditions for temperature limited by fuse		N/A

IEC 62368-1			
Clause	Requirement + Test	Result - Remark	Verdict
6.4.4	Control of fire spread in PS1 circuits		P
6.4.5	Control of fire spread in PS2 circuits		N/A
6.4.5.2	Supplementary safeguards		N/A
6.4.6	Control of fire spread in PS3 circuit		N/A
6.4.7	Separation of combustible materials from a PIS	No PIS	P
6.4.7.1	General.....		N/A
6.4.7.2	Separation by distance		N/A
6.4.7.3	Separation by a fire barrier		N/A
6.4.8	Fire enclosures and fire barriers		N/A
6.4.8.1	Fire enclosure and fire barrier material properties		N/A
6.4.8.2.1	Requirements for a fire barrier	No such barrier used.	N/A
6.4.8.2.2	Requirements for a fire enclosure		N/A
6.4.8.3	Constructional requirements for a fire enclosure and a fire barrier		N/A
6.4.8.3.1	Fire enclosure and fire barrier openings	No openings on the fire enclosure.	N/A
6.4.8.3.2	Fire barrier dimensions		N/A
6.4.8.3.3	Top Openings in Fire Enclosure: dimensions (mm)		N/A
	Needle Flame test		N/A
6.4.8.3.4	Bottom Openings in Fire Enclosure, condition met a), b) and/or c) dimensions (mm)		N/A
	Flammability tests for the bottom of a fire enclosure		N/A
6.4.8.3.5	Integrity of the fire enclosure, condition met: a), b) or c)		N/A
6.4.8.4	Separation of PIS from fire enclosure and fire barrier distance (mm) or flammability rating.....		N/A
6.5	Internal and external wiring		P
6.5.1	Requirements		P
6.5.2	Cross-sectional area (mm ²)	(See appended table 4.1.2)	—
6.5.3	Requirements for interconnection to building wiring		N/A
6.6	Safeguards against fire due to connection to additional equipment		N/A
	External port limited to PS2 or complies with Clause Q.1	See appended table Annex Q.1	N/A

7	INJURY CAUSED BY HAZARDOUS SUBSTANCES		N/A
7.2	Reduction of exposure to hazardous substances	No such hazardous substances	N/A

IEC 62368-1			
Clause	Requirement + Test	Result - Remark	Verdict
7.3	Ozone exposure	No ozone production	N/A
7.4	Use of personal safeguards (PPE)		N/A
	Personal safeguards and instructions :		—
7.5	Use of instructional safeguards and instructions		N/A
	Instructional safeguard (ISO 7010):		—
7.6	Batteries:	(See appended tables Annex M)	N/A

8	MECHANICALLY-CAUSED INJURY		P
8.1	General		P
8.2	Mechanical energy source classifications		P
8.3	Safeguards against mechanical energy sources		P
8.4	Safeguards against parts with sharp edges and corners		P
8.4.1	Safeguards	MS1 classification	N/A
8.5	Safeguards against moving parts		N/A
8.5.1	MS2 or MS3 part required to be accessible for the function of the equipment		N/A
8.5.2	Instructional Safeguard..... :		—
8.5.4	Special categories of equipment comprising moving parts		N/A
8.5.4.1	Large data storage equipment		N/A
8.5.4.2	Equipment having electromechanical device for destruction of media		N/A
8.5.4.2.1	Safeguards and Safety Interlocks:		N/A
8.5.4.2.2	Instructional safeguards against moving parts		N/A
	Instructional Safeguard.....:		—
8.5.4.2.3	Disconnection from the supply		N/A
8.5.4.2.4	Probe type and force (N):		N/A
8.5.5	High Pressure Lamps		N/A
8.5.5.1	Energy Source Classification		N/A
8.5.5.2	High Pressure Lamp Explosion Test.....:		N/A
8.6	Stability	Mass < 7kg	N/A
8.6.1	Product classification	MS1	N/A
	Instructional Safeguard.....:		—
8.6.2	Static stability		N/A
8.6.2.2	Static stability test		N/A
	Applied Force:		—

IEC 62368-1			
Clause	Requirement + Test	Result - Remark	Verdict
8.6.2.3	Downward Force Test		N/A
8.6.3	Relocation stability test		N/A
	Unit configuration during 10° tilt		—
8.6.4	Glass slide test		N/A
8.6.5	Horizontal force test (Applied Force).....		N/A
	Position of feet or movable parts.....		—
8.7	Equipment mounted to wall or ceiling		N/A
8.7.1	Mounting Means (Length of screws (mm) and mounting surface)		N/A
8.7.2	Direction and applied force.....		N/A
8.8	Handles strength		N/A
8.8.1	Classification		N/A
8.8.2	Applied Force		N/A
8.9	Wheels or casters attachment requirements		N/A
8.9.1	Classification		N/A
8.9.2	Applied force		—
8.10	Carts, stands and similar carriers		N/A
8.10.1	General		N/A
8.10.2	Marking and instructions		N/A
	Instructional Safeguard.....		—
8.10.3	Cart, stand or carrier loading test and compliance		N/A
	Applied force		—
8.10.4	Cart, stand or carrier impact test		N/A
8.10.5	Mechanical stability		N/A
	Applied horizontal force (N)		—
8.10.6	Thermoplastic temperature stability (°C).....		N/A
8.11	Mounting means for rack mounted equipment		N/A
8.11.1	General		N/A
8.11.2	Product Classification		N/A
8.11.3	Mechanical strength test, variable N		N/A
8.11.4	Mechanical strength test 250N, including end stops		N/A
8.12	Telescoping or rod antennas.....		N/A
	Button/Ball diameter (mm).....		—

9	THERMAL BURN INJURY		P
9.2	Thermal energy source classifications	TS1: accessible parts	P

IEC 62368-1			
Clause	Requirement + Test	Result - Remark	Verdict
9.3	Safeguard against thermal energy sources		N/A
9.4	Requirements for safeguards		N/A
9.4.1	Equipment safeguard		N/A
9.4.2	Instructional safeguard		N/A

10	RADIATION		N/A
10.2	Radiation energy source classification		N/A
10.2.1	General classification		N/A
10.3	Protection against laser radiation	No laser radiation	N/A
	Laser radiation that exists equipment:		—
	Normal, abnormal, single-fault		N/A
	Instructional safeguard		—
	Tool.....		—
10.4	Protection against visible, infrared, and UV radiation		N/A
10.4.1	General		N/A
10.4.1.a)	RS3 for Ordinary and instructed persons		N/A
10.4.1.b)	RS3 accessible to a skilled person.....		N/A
	Personal safeguard (PPE) instructional safeguard.....		—
10.4.1.c)	Equipment visible, IR, UV does not exceed RS1. :		N/A
10.4.1.d)	Normal, abnormal, single-fault conditions		N/A
10.4.1.e)	Enclosure material employed as safeguard is opaque.....		N/A
10.4.1.f)	UV attenuation.....		N/A
10.4.1.g)	Materials resistant to degradation UV		N/A
10.4.1.h)	Enclosure containment of optical radiation.....		N/A
10.4.1.i)	Exempt Group under normal operating conditions		N/A
10.4.2	Instructional safeguard		N/A
10.5	Protection against x-radiation		N/A
10.5.1	X- radiation energy source that exists equipment :		N/A
	Normal, abnormal, single fault conditions		N/A
	Equipment safeguards.....		N/A
	Instructional safeguard for skilled person.....		N/A
10.5.3	Most unfavourable supply voltage to give maximum radiation		—
	Abnormal and single-fault condition		N/A

IEC 62368-1			
Clause	Requirement + Test	Result - Remark	Verdict
	Maximum radiation (pA/kg)..... :		N/A
10.6	Protection against acoustic energy sources		N/A
10.6.1	General		N/A
10.6.2	Classification		N/A
	Acoustic output, dB(A)..... :		N/A
	Output voltage, unweighted r.m.s..... :		N/A
10.6.4	Protection of persons		N/A
	Instructional safeguards :		N/A
	Equipment safeguard prevent ordinary person to RS2..... :		—
	Means to actively inform user of increase sound pressure..... :		—
	Equipment safeguard prevent ordinary person to RS2..... :		—
10.6.5	Requirements for listening devices (headphones, earphones, etc.)		N/A
10.6.5.1	Corded passive listening devices with analog input		N/A
	Input voltage with 94 dB(A) L_{Aeq} acoustic pressure output..... :		—
10.6.5.2	Corded listening devices with digital input		N/A
	Maximum dB(A)..... :		—
10.6.5.3	Cordless listening device		N/A
	Maximum dB(A)..... :		—

B	NORMAL OPERATING CONDITION TESTS, ABNORMAL OPERATING CONDITION TESTS AND SINGLE FAULT CONDITION TESTS		P
B.2	Normal Operating Conditions		P
B.2.1	General requirements..... :	(See summary of testing & appended test tables)	P
	Audio Amplifiers and equipment with audio amplifiers :	(See appended table B.2.5)	N/A
B.2.3	Supply voltage and tolerances		N/A
B.2.5	Input test..... :		N/A
B.3	Simulated abnormal operating conditions		P
B.3.1	General requirements..... :	(See appended table B.3)	P
B.3.2	Covering of ventilation openings		N/A
B.3.3	D.C. mains polarity test		N/A
B.3.4	Setting of voltage selector..... :	No such voltage selector.	N/A

IEC 62368-1			
Clause	Requirement + Test	Result - Remark	Verdict
B.3.5	Maximum load at output terminals	No such terminals	N/A
B.3.6	Reverse battery polarity		N/A
B.3.7	Abnormal operating conditions as specified in Clause E.2.	(See appended table B.3)	P
B.3.8	Safeguards functional during and after abnormal operating conditions		P
B.4	Simulated single fault conditions		P
B.4.2	Temperature controlling device open or short-circuited		N/A
B.4.3	Motor tests		N/A
B.4.3.1	Motor blocked or rotor locked increasing the internal ambient temperature		N/A
B.4.4	Short circuit of functional insulation		P
B.4.4.1	Short circuit of clearances for functional insulation	(See appended table B.4)	P
B.4.4.2	Short circuit of creepage distances for functional insulation	(See appended table B.4)	P
B.4.4.3	Short circuit of functional insulation on coated printed boards		N/A
B.4.5	Short circuit and interruption of electrodes in tubes and semiconductors	(See appended table B.4)	P
B.4.6	Short circuit or disconnect of passive components	(See appended table B.4)	P
B.4.7	Continuous operation of components		N/A
B.4.8	Class 1 and Class 2 energy sources within limits during and after single fault conditions		P
B.4.9	Battery charging under single fault conditions ... :		N/A

C	UV RADIATION		N/A
C.1	Protection of materials in equipment from UV radiation	No UV radiation within the EUT.	N/A
C.1.2	Requirements		N/A
C.1.3	Test method		N/A
C.2	UV light conditioning test		N/A
C.2.1	Test apparatus		N/A
C.2.2	Mounting of test samples		N/A
C.2.3	Carbon-arc light-exposure apparatus		N/A
C.2.4	Xenon-arc light exposure apparatus		N/A

D	TEST GENERATORS		N/A
D.1	Impulse test generators		N/A

IEC 62368-1			
Clause	Requirement + Test	Result - Remark	Verdict
D.2	Antenna interface test generator		N/A
D.3	Electronic pulse generator		N/A

E	TEST CONDITIONS FOR EQUIPMENT CONTAINING AUDIO AMPLIFIERS	N/A
E.1	Audio amplifier normal operating conditions	N/A
	Audio signal voltage (V)	—
	Rated load impedance (Ω)	
E.2	Audio amplifier abnormal operating conditions	N/A

F	EQUIPMENT MARKINGS, INSTRUCTIONS, AND INSTRUCTIONAL SAFEGUARDS	P
F.1	General requirements	P
	Instructions – Language	English checked
F.2	Letter symbols and graphical symbols	P
F.2.1	Letter symbols according to IEC60027-1	P
F.2.2	Graphic symbols IEC, ISO or manufacturer specific	P
F.3	Equipment markings	P
F.3.1	Equipment marking locations	Located on the external enclosure surface
F.3.2	Equipment identification markings	P
F.3.2.1	Manufacturer identification	See rating label
F.3.2.2	Model identification	See rating label
F.3.3	Equipment rating markings	N/A
F.3.3.1	Equipment with direct connection to mains	N/A
F.3.3.2	Equipment without direct connection to mains	P
F.3.3.3	Nature of supply voltage	—
F.3.3.4	Rated voltage	—
F.3.3.4	Rated frequency	—
F.3.3.6	Rated current or rated power	—
F.3.3.7	Equipment with multiple supply connections	No multiple supply connection.
F.3.4	Voltage setting device	No such device.
F.3.5	Terminals and operating devices	N/A
F.3.5.1	Mains appliance outlet and socket-outlet markings	No mains appliance outlet.
F.3.5.2	Switch position identification marking	Not such switch.
F.3.5.3	Replacement fuse identification and rating markings	N/A

IEC 62368-1			
Clause	Requirement + Test	Result - Remark	Verdict
F.3.5.4	Replacement battery identification marking :	Provided the user manual	P
F.3.5.5	Terminal marking location		N/A
F.3.6	Equipment markings related to equipment classification		N/A
F.3.6.1	Class I Equipment		N/A
F.3.6.1.1	Protective earthing conductor terminal		N/A
F.3.6.1.2	Neutral conductor terminal		N/A
F.3.6.1.3	Protective bonding conductor terminals		N/A
F.3.6.2	Class II equipment (IEC60417-5172)		N/A
F.3.6.2.1	Class II equipment with or without functional earth		N/A
F.3.6.2.2	Class II equipment with functional earth terminal marking		N/A
F.3.7	Equipment IP rating marking :	IP20	—
F.3.8	External power supply output marking		N/A
F.3.9	Durability, legibility and permanence of marking		P
F.3.10	Test for permanence of markings		P
F.4	Instructions		P
	a) Equipment for use in locations where children not likely to be present - marking		N/A
	b) Instructions given for installation or initial use		P
	c) Equipment intended to be fastened in place		N/A
	d) Equipment intended for use only in restricted access area	Not used in restricted access area.	N/A
	e) Audio equipment terminals classified as ES3 and other equipment with terminals marked in accordance F.3.6.1		N/A
	f) Protective earthing employed as safeguard		N/A
	g) Protective earthing conductor current exceeding ES2 limits		N/A
	h) Symbols used on equipment		N/A
	i) Permanently connected equipment not provided with all-pole mains switch		N/A
	j) Replaceable components or modules providing safeguard function		N/A
F.5	Instructional safeguards		N/A
	Where “instructional safeguard” is referenced in the test report it specifies the required elements, location of marking and/or instruction		N/A
G	COMPONENTS		P
G.1	Switches		N/A

IEC 62368-1			
Clause	Requirement + Test	Result - Remark	Verdict
G.1.1	General requirements		N/A
G.1.2	Ratings, endurance, spacing, maximum load		N/A
G.2	Relays		N/A
G.2.1	General requirements		N/A
G.2.2	Overload test		N/A
G.2.3	Relay controlling connectors supply power		N/A
G.2.4	Mains relay, modified as stated in G.2		N/A
G.3	Protection Devices		N/A
G.3.1	Thermal cut-offs	No thermal cut-off used.	N/A
G.3.1.1a) &b)	Thermal cut-outs separately approved according to IEC 60730 with conditions indicated in a) & b)		N/A
G.3.1.1c)	Thermal cut-outs tested as part of the equipment as indicated in c)		N/A
G.3.1.2	Thermal cut-off connections maintained and secure		N/A
G.3.2	Thermal links		N/A
G.3.2.1a)	Thermal links separately tested with IEC 60691	No thermal link used.	N/A
G.3.2.1b)	Thermal links tested as part of the equipment		N/A
	Aging hours (H)		—
	Single Fault Condition		—
	Test Voltage (V) and Insulation Resistance (Ω) . :		—
G.3.3	PTC Thermistors		N/A
G.3.4	Overcurrent protection devices		N/A
G.3.5	Safeguards components not mentioned in G.3.1 to G.3.5		N/A
G.3.5.1	Non-resettable devices suitably rated and marking provided		N/A
G.3.5.2	Single faults conditions.....:		N/A
G.4	Connectors		N/A
G.4.1	Spacings	Not directly connected to mains	N/A
G.4.2	Mains connector configuration		N/A
G.4.3	Plug is shaped that insertion into mains socket-outlets or appliance coupler is unlikely		N/A
G.5	Wound Components		N/A
G.5.1	Wire insulation in wound components..... :		N/A
G.5.1.2 a)	Two wires in contact inside wound component, angle between 45° and 90°		N/A
G.5.1.2 b)	Construction subject to routine testing		N/A
G.5.2	Endurance test on wound components		N/A

IEC 62368-1			
Clause	Requirement + Test	Result - Remark	Verdict
G.5.2.1	General test requirements		N/A
G.5.2.2	Heat run test		N/A
	Time (s)		—
	Temperature (°C)		—
G.5.2.3	Wound Components supplied by mains		N/A
G.5.3	Transformers		N/A
G.5.3.1	Requirements applied (IEC61204-7, IEC61558-1/-2, and/or IEC62368-1)		N/A
	Position.....		—
	Method of protection		—
G.5.3.2	Insulation		N/A
	Protection from displacement of windings.....		—
G.5.3.3	Overload test		N/A
G.5.3.3.1	Test conditions		N/A
G.5.3.3.2	Winding Temperatures testing in the unit		N/A
G.5.3.3.3	Winding Temperatures - Alternative test method		N/A
G.5.4	Motors		N/A
G.5.4.1	General requirements		N/A
	Position		—
G.5.4.2	Test conditions		N/A
G.5.4.3	Running overload test		N/A
G.5.4.4	Locked-rotor overload test		N/A
	Test duration (days)		—
G.5.4.5	Running overload test for d.c. motors in secondary circuits		N/A
G.5.4.5.2	Tested in the unit		N/A
	Electric strength test (V)		—
G.5.4.5.3	Tested on the Bench - Alternative test method; test time (h)		N/A
	Electric strength test (V)		—
G.5.4.6	Locked-rotor overload test for d.c. motors in secondary circuits		N/A
G.5.4.6.2	Tested in the unit		N/A
	Maximum Temperature		N/A
	Electric strength test (V)		N/A
G.5.4.6.3	Tested on the bench - Alternative test method; test time (h)		N/A
	Electric strength test (V)		N/A

IEC 62368-1			
Clause	Requirement + Test	Result - Remark	Verdict
G.5.4.7	Motors with capacitors		N/A
G.5.4.8	Three-phase motors		N/A
G.5.4.9	Series motors		N/A
	Operating voltage		—
G.6	Wire Insulation		N/A
G.6.1	General		N/A
G.6.2	Solvent-based enamel wiring insulation		N/A
G.7	Mains supply cords		N/A
G.7.1	General requirements	Not directly connected to mains	N/A
	Type.....		—
	Rated current (A).....		—
	Cross-sectional area (mm ²), (AWG)		—
G.7.2	Compliance and test method		N/A
G.7.3	Cord anchorages and strain relief for non-detachable power supply cords		N/A
G.7.3.2	Cord strain relief		N/A
G.7.3.2.1	Requirements		N/A
	Strain relief test force (N)		—
G.7.3.2.2	Strain relief mechanism failure		N/A
G.7.3.2.3	Cord sheath or jacket position, distance (mm)....		—
G.7.3.2.4	Strain relief comprised of polymeric material		N/A
G.7.4	Cord Entry		N/A
G.7.5	Non-detachable cord bend protection		N/A
G.7.5.1	Requirements		N/A
G.7.5.2	Mass (g)		—
	Diameter (m)		—
	Temperature (°C)		—
G.7.6	Supply wiring space		N/A
G.7.6.2	Stranded wire		N/A
G.7.6.2.1	Test with 8 mm strand		N/A
G.8	Varistors		N/A
G.8.1	General requirements	No varistors used.	N/A
G.8.2	Safeguard against shock		N/A
G.8.3	Safeguard against fire		N/A
G.8.3.2	Varistor overload test		N/A
G.8.3.3	Temporary overvoltage		N/A

IEC 62368-1			
Clause	Requirement + Test	Result - Remark	Verdict
G.9	Integrated Circuit (IC) Current Limiters		N/A
G.9.1 a)	Manufacturer defines limit at max. 5A.	No such IC used.	N/A
G.9.1 b)	Limiters do not have manual operator or reset		N/A
G.9.1 c)	Supply source does not exceed 250 VA		—
G.9.1 d)	IC limiter output current (max. 5A)		—
G.9.1 e)	Manufacturers' defined drift		—
G.9.2	Test Program 1		N/A
G.9.3	Test Program 2		N/A
G.9.4	Test Program 3		N/A
G.10	Resistors		N/A
G.10.1	General requirements		N/A
G.10.2	Resistor test		N/A
G.10.3	Test for resistors serving as safeguards between the mains and an external circuit consisting of a coaxial cable		N/A
G.10.3.1	General requirements		N/A
G.10.3.2	Voltage surge test		N/A
G.10.3.3	Impulse test		N/A
G.11	Capacitor and RC units		N/A
G.11.1	General requirements	No such components used	N/A
G.11.2	Conditioning of capacitors and RC units		N/A
G.11.3	Rules for selecting capacitors		N/A
G.12	Optocouplers		N/A
	Optocouplers comply with IEC 60747-5-5:2007 Spacing or Electric Strength Test (specify option and test results).....		N/A
	Type test voltage Vini		—
	Routine test voltage, Vini,b		—
G.13	Printed boards		P
G.13.1	General requirements		P
G.13.2	Uncoated printed boards		P
G.13.3	Coated printed boards		N/A
G.13.4	Insulation between conductors on the same inner surface		N/A
	Compliance with cemented joint requirements (Specify construction).....		—
G.13.5	Insulation between conductors on different surfaces		N/A
	Distance through insulation.....		N/A

IEC 62368-1			
Clause	Requirement + Test	Result - Remark	Verdict
	Number of insulation layers (pcs)		—
G.13.6	Tests on coated printed boards		N/A
G.13.6.1	Sample preparation and preliminary inspection		N/A
G.13.6.2a)	Thermal conditioning		N/A
G.13.6.2b)	Electric strength test		N/A
G.13.6.2c)	Abrasion resistance test		N/A
G.14	Coating on components terminals		N/A
G.14.1	Requirements		N/A
G.15	Liquid filled components		N/A
G.15.1	General requirements		N/A
G.15.2	Requirements		N/A
G.15.3	Compliance and test methods		N/A
G.15.3.1	Hydrostatic pressure test		N/A
G.15.3.2	Creep resistance test		N/A
G.15.3.3	Tubing and fittings compatibility test		N/A
G.15.3.4	Vibration test		N/A
G.15.3.5	Thermal cycling test		N/A
G.15.3.6	Force test		N/A
G.15.4	Compliance		N/A
G.16	IC including capacitor discharge function (ICX)		N/A
a)	Humidity treatment in accordance with sc5.4.8 – 120 hours		N/A
b)	Impulse test using circuit 2 with $U_c =$ to transient voltage		N/A
C1)	Application of ac voltage at 110% of rated voltage for 2.5 minutes		N/A
C2)	Test voltage		—
D1)	10,000 cycles on and off using capacitor with smallest capacitance resistor with largest resistance specified by manufacturer		N/A
D2)	Capacitance		—
D3)	Resistance		—
H	CRITERIA FOR TELEPHONE RINGING SIGNALS		N/A
H.1	General		N/A
H.2	Method A		N/A
H.3	Method B		N/A
H.3.1	Ringing signal		N/A
H.3.1.1	Frequency (Hz)		—

IEC 62368-1			
Clause	Requirement + Test	Result - Remark	Verdict
H.3.1.2	Voltage (V)		—
H.3.1.3	Cadence; time (s) and voltage (V)		—
H.3.1.4	Single fault current (mA):.....		—
H.3.2	Tripping device and monitoring voltage		N/A
H.3.2.1	Conditions for use of a tripping device or a monitoring voltage complied with		N/A
H.3.2.2	Tripping device		N/A
H.3.2.3	Monitoring voltage (V)		—
J	INSULATED WINDING WIRES FOR USE WITHOUT INTERLEAVED INSULATION		N/A
	General requirements		N/A
K	SAFETY INTERLOCKS		N/A
K.1	General requirements	No safety interlocks inside the EUT	N/A
K.2	Components of safety interlock safeguard mechanism		N/A
K.3	Inadvertent change of operating mode		N/A
K.4	Interlock safeguard override		N/A
K.5	Fail-safe		N/A
	Compliance		N/A
K.6	Mechanically operated safety interlocks		N/A
K.6.1	Endurance requirement		N/A
K.6.2	Compliance and Test method		N/A
K.7	Interlock circuit isolation		N/A
K.7.1	Separation distance for contact gaps & interlock circuit elements (type and circuit location)		N/A
K.7.2	Overload test, Current (A)		N/A
K.7.3	Endurance test		N/A
K.7.4	Electric strength test		N/A
L	DISCONNECT DEVICES		N/A
L.1	General requirements		N/A
L.2	Permanently connected equipment		N/A
L.3	Parts that remain energized		N/A
L.4	Single phase equipment		N/A
L.5	Three-phase equipment		N/A
L.6	Switches as disconnect devices		N/A
L.7	Plugs as disconnect devices		N/A
L.8	Multiple power sources		N/A

IEC 62368-1			
Clause	Requirement + Test	Result - Remark	Verdict
M	EQUIPMENT CONTAINING BATTERIES AND THEIR PROTECTION CIRCUITS		P
M.1	General requirements	Internal non-rechargeable battery was certificated	P
M.2	Safety of batteries and their cells		P
M.2.1	Requirements	Internal non-rechargeable battery was certificated according IEC 60086-4	P
M.2.2	Compliance and test method (identify method) .. :		P
M.3	Protection circuits		N/A
M.3.1	Requirements		P
M.3.2	Tests		N/A
	- Overcharging of a rechargeable battery	non-rechargeable battery	N/A
	- Unintentional charging of a non-rechargeable battery		N/A
	- Reverse charging of a rechargeable battery		N/A
	- Excessive discharging rate for any battery		P
M.3.3	Compliance	After above test have not created a hazard in the meaning of this standard	N/A
M.4	Additional safeguards for equipment containing secondary lithium battery		N/A
M.4.1	General		N/A
M.4.2	Charging safeguards		N/A
M.4.2.1	Charging operating limits		N/A
M.4.2.2a)	Charging voltage, current and temperature	(See appended table M.4)	—
M.4.2.2 b)	Single faults in charging circuitry	(See appended table M.4)	—
M.4.3	Fire Enclosure		N/A
M.4.4	Endurance of equipment containing a secondary lithium battery		N/A
M.4.4.2	Preparation		N/A
M.4.4.3	Drop and charge/discharge function tests		N/A
	Drop		N/A
	Charge		N/A
	Discharge		N/A
M.4.4.4	Charge-discharge cycle test		N/A
M.4.4.5	Result of charge-discharge cycle test		N/A
M.5	Risk of burn due to short circuit during carrying	See appended table B.4	N/A
M.5.1	Requirement		N/A
M.5.2	Compliance and Test Method (Test of P.2.3)		N/A

IEC 62368-1			
Clause	Requirement + Test	Result - Remark	Verdict
M.6	Prevention of short circuits and protection from other effects of electric current	See appended table B.4	N/A
M.6.1	Short circuits		N/A
M.6.1.1	General requirements		N/A
M.6.1.2	Test method to simulate an internal fault		N/A
M.6.1.3	Compliance (Specify M.6.1.2 or alternative method)		N/A
M.6.2	Leakage current (mA)		N/A
M.7	Risk of explosion from lead acid and NiCd batteries		N/A
M.7.1	Ventilation preventing explosive gas concentration		N/A
M.7.2	Compliance and test method		N/A
M.8	Protection against internal ignition from external spark sources of lead acid batteries		N/A
M.8.1	General requirements		N/A
M.8.2	Test method		N/A
M.8.2.1	General requirements		N/A
M.8.2.2	Estimation of hypothetical volume Vz (m ³ /s).....		—
M.8.2.3	Correction factors.....		—
M.8.2.4	Calculation of distance d (mm)		—
M.9	Preventing electrolyte spillage		N/A
M.9.1	Protection from electrolyte spillage		N/A
M.9.2	Tray for preventing electrolyte spillage		N/A
M.10	Instructions to prevent reasonably foreseeable misuse (Determination of compliance: inspection, data review; or abnormal testing)		N/A
N	ELECTROCHEMICAL POTENTIALS		N/A
	Metal(s) used		—
O	MEASUREMENT OF CREEPAGE DISTANCES AND CLEARANCES		N/A
	Figures O.1 to O.20 of this Annex applied.....	Considered	—
P	SAFEGUARDS AGAINST ENTRY OF FOREIGN OBJECTS AND SPILLAGE OF INTERNAL LIQUIDS		P
P.1	General requirements	Not connect to hazard parts	P
P.2.2	Safeguards against entry of foreign object	No safeguards requirement.	N/A
	Location and Dimensions (mm)		—
P.2.3	Safeguard against the consequences of entry of foreign object		N/A
P.2.3.1	Safeguards against the entry of a foreign object		N/A

IEC 62368-1			
Clause	Requirement + Test	Result - Remark	Verdict
	Openings in transportable equipment		N/A
	Transportable equipment with metalized plastic parts		N/A
P.2.3.2	Openings in transportable equipment in relation to metallized parts of a barrier or enclosure (identification of supplementary safeguard)		N/A
P.3	Safeguards against spillage of internal liquids		N/A
P.3.1	General requirements		N/A
P.3.2	Determination of spillage consequences		N/A
P.3.3	Spillage safeguards		N/A
P.3.4	Safeguards effectiveness		N/A
P.4	Metallized coatings and adhesive securing parts		N/A
P.4.2 a)	Conditioning testing		N/A
	Tc (°C).....		—
	Tr (°C)		—
	Ta (°C).....		—
P.4.2 b)	Abrasion testing		N/A
P.4.2 c)	Mechanical strength testing		N/A
Q	CIRCUITS INTENDED FOR INTERCONNECTION WITH BUILDING WIRING		N/A
Q.1	Limited power sources		N/A
Q.1.1 a)	Inherently limited output		N/A
Q.1.1 b)	Impedance limited output		N/A
	- Regulating network limited output under normal operating and simulated single fault condition	See appended table Annex Q.1	N/A
Q.1.1 c)	Overcurrent protective device limited output		N/A
Q.1.1 d)	IC current limiter complying with G.9		N/A
Q.1.2	Compliance and test method		N/A
Q.2	Test for external circuits – paired conductor cable		N/A
	Maximum output current (A)		—
	Current limiting method.....		—
R	LIMITED SHORT CIRCUIT TEST		N/A
R.1	General requirements		N/A
R.2	Determination of the overcurrent protective device and circuit		N/A
R.3	Test method Supply voltage (V) and short-circuit current (A).		N/A

IEC 62368-1			
Clause	Requirement + Test	Result - Remark	Verdict
S	TESTS FOR RESISTANCE TO HEAT AND FIRE		N/A
S.1	Flammability test for fire enclosures and fire barrier materials of equipment where the steady state power does not exceed 4 000 W		N/A
	Samples, material		—
	Wall thickness (mm).....		—
	Conditioning (°C).....		—
	Test flame according to IEC 60695-11-5 with conditions as set out		N/A
	- Material not consumed completely		N/A
	- Material extinguishes within 30s		N/A
	- No burning of layer or wrapping tissue		N/A
S.2	Flammability test for fire enclosure and fire barrier integrity		N/A
	Samples, material		—
	Wall thickness (mm).....		—
	Conditioning (°C).....		—
	Test flame according to IEC 60695-11-5 with conditions as set out		N/A
	Test specimen does not show any additional hole		N/A
S.3	Flammability test for the bottom of a fire enclosure		N/A
	Samples, material		—
	Wall thickness (mm).....		—
	Cheesecloth did not ignite		N/A
S.4	Flammability classification of materials		N/A
S.5	Flammability test for fire enclosures and fire barrier materials of equipment where the steady state power does not exceed 4 000 W		N/A
	Samples, material		—
	Wall thickness (mm).....		—
	Conditioning (test condition), (°C).....		—
	Test flame according to IEC 60695-11-20 with conditions as set out		N/A
	After every test specimen was not consumed completely		N/A
	After fifth flame application, flame extinguished within 1 min		N/A
T	MECHANICAL STRENGTH TESTS		P
T.1	General requirements		P

IEC 62368-1			
Clause	Requirement + Test	Result - Remark	Verdict
T.2	Steady force test, 10 N		N/A
T.3	Steady force test, 30 N		N/A
T.4	Steady force test, 100 N		P
T.5	Steady force test, 250 N		N/A
T.6	Enclosure impact test		N/A
	Fall test		N/A
	Swing test		N/A
T.7	Drop test	(See appended table T.7)	P
T.8	Stress relief test	(See appended table T.8)	N/A
T.9	Impact Test (glass)	No glass used	N/A
T.9.1	General requirements		N/A
T.9.2	Impact test and compliance		N/A
	Impact energy (J).....		—
	Height (m)		—
T.10	Glass fragmentation test		N/A
T.11	Test for telescoping or rod antennas		N/A
	Torque value (Nm)		—
U	MECHANICAL STRENGTH OF CATHODE RAY TUBES (CRT) AND PROTECTION AGAINST THE EFFECTS OF IMPLOSION		N/A
U.1	General requirements		N/A
U.2	Compliance and test method for non-intrinsically protected CRTs		N/A
U.3	Protective Screen.....		N/A
V	DETERMINATION OF ACCESSIBLE PARTS (FINGERS, PROBES AND WEDGES)		P
V.1	Accessible parts of equipment		P
V.2	Accessible part criterion		P

IEC 62368-1			
Clause	Requirement + Test	Result - Remark	Verdict

4.1.2	TABLE: List of critical components					P
Object / part No.	Manufacturer/ trademark	Type / model	Technical data	Standard	Mark(s) of conformity ¹	
Plastic enclosure	Celanese (Suzhou) Engineering Plastics Co., Ltd.	A3 RV0 (a)(b)(f2), A 63 R V0 (a)(b)(f2)	V-0, 105°C	UL 94	UL E331274	
PCB	SHENZHEN XINGAOQIANG ELECTRONICS CO., LTD.	XGQ-D	V-0, 130°C	UL 796	UL E510906	
(Alternative)	Interchangeable	Interchangeable	V-0, 130°C	UL 796	UL	
Internal Li/SOCl ₂ battery	EVE Energy Co., Ltd.	ER 18505	3.6V, 3.8Ah	IEC 60086-4	Vkan Report No.: GJW2017-0490	

Supplementary information:

1) an asterisk indicates a mark which assures the agreed level of surveillance.

4.8.4, 4.8.5	TABLE: Lithium coin/button cell batteries mechanical tests			N/A
(The following mechanical tests are conducted in the sequence noted.)				
4.8.4.2	TABLE: Stress Relief test			—
Part	Material	Oven Temperature (°C)	Comments	
--	--	--	--	
4.8.4.3	TABLE: Battery replacement test			—
Battery part no.:				
Battery Installation/withdrawal		Battery Installation/Removal Cycle	Comments	
		1	--	
		2	--	
		3	--	
		4	--	
		5	--	
		6	--	
		8	--	
		9	--	
		10	--	
4.8.4.4	TABLE: Drop test			—
Impact Area	Drop Distance	Drop No.	Observations	

IEC 62368-1			
Clause	Requirement + Test	Result - Remark	Verdict
4.8.4, 4.8.5	TABLE: Lithium coin/button cell batteries mechanical tests		N/A
(The following mechanical tests are conducted in the sequence noted.)			
--	--	1	--
--	--	2	--
--	--	3	--
4.8.4.5	TABLE: Impact		---
Impacts per surface	Surface tested	Impact energy (Nm)	Comments
--	--	--	--
4.8.4.6	TABLE: Crush test		---
Test position	Surface tested	Crushing Force (N)	Duration force applied (s)
--	--	--	--
Supplementary information:			

4.8.5	TABLE: Lithium coin/button cell batteries mechanical test result		N/A
Test position	Surface tested	Force (N)	Duration force applied (s)
--	--	--	--
Supplementary information:			

5.2	Table: Classification of electrical energy sources					P	
5.2.2.2 – Steady State Voltage and Current conditions							
No.	Supply Voltage	Location (e.g. circuit designation)	Test conditions	Parameters			ES Class
				U (Vrms or Vpk)	I (A _{pk} or A _{rms})	Hz	
1	--	Internal circuit	Normal	3.6VDC	--	--	ES1
			Abnormal: --	3.6VDC	--	--	
			Single fault: -	3.6VDC	--	--	
5.2.2.3 – Capacitance Limits							
No.	Supply Voltage	Location (e.g. circuit designation)	Test conditions	Parameters		ES Class	
				Capacitance, nF	Upk (V)		
--	--	--	Normal:	--	--	--	
			Abnormal: --	--	--		

IEC 62368-1			
Clause	Requirement + Test	Result - Remark	Verdict

		Single fault: SC/OC	--	--	
--	--	---------------------	----	----	--

5.2.2.4 – Single Pulses

No.	Supply Voltage	Location (e.g. circuit designation)	Test conditions	Parameters			ES Class
				Duration (ms)	Upk (V)	Ipk (mA)	
--	--	--	Normal	--	--	--	--
			Abnormal	--	--	--	
			Single fault – SC/OC	--	--	--	

5.2.2.5 – Repetitive Pulses

No.	Supply Voltage	Location (e.g. circuit designation)	Test conditions	Parameters			ES Class
				Off time (ms)	Upk (V)	Ipk (mA)	
--	--	--	Normal	--	--	--	--
			Abnormal	--	--	--	
			Single fault – SC/OC	--	--	--	

Test Conditions:

- Normal –
- Abnormal –

Supplementary information: SC=Short Circuit, OC=Open Circuit

The prospective touch voltage was measured when the flash device was ignited.

5.4.1.4, 6.3.2, 9.0, B.2.6	TABLE: Thermal requirements					P
Supply voltage (V)	3.6	3.6	--	--	---	
Ambient T _{min} (°C)	25.0	40.0	--	--	---	
Ambient T _{max} (°C)	25.0	40.0	--	--	---	
Maximum measured temperature T of part/at.....:	T (°C)				Allowed T _{max} (°C)	
PCB near U1	39.8	54.8	--	--	130	
PCB near U2	38.6	53.6	--	--	130	
Internal wire of battery	30.3	45.3	--	--	80	
Battery body	32.9	47.9	--	--	Ref.	
Enclosure inside near PCB	28.6	43.6	--	--	Ref.	

IEC 62368-1							
Clause	Requirement + Test			Result - Remark			Verdict
Touch temperature clause 9.0							
Enclosure outside near PCB	27.5	--	--	--	--	--	77
Supplementary information:							
Temperature T of winding:	t ₁ (°C)	R ₁ (Ω)	t ₂ (°C)	R ₂ (Ω)	T (°C)	Allowed T _{max} (°C)	Insulation class
--	--	--	--	--	--	--	--
Supplementary information: powered by Li/SOCl ₂ battery.							

5.4.1.10.2	TABLE: Vicat softening temperature of thermoplastics			N/A
Penetration (mm)..... :				—
Object/ Part No./Material	Manufacturer/t rademark	T softening (°C)		
--	--	--		
Supplementary information:				

5.4.1.10.3	TABLE: Ball pressure test of thermoplastics			N/A
Allowed impression diameter (mm)	≤ 2 mm			—
Object/Part No./Material	Manufacturer/trademark	Test temperature (°C)	Impression diameter (mm)	
--	--	--	--	
Supplementary information:				

5.4.2.2, 5.4.2.4 and 5.4.3	TABLE: Minimum Clearances/Creepage distance							N/A
Clearance (cl) and creepage distance (cr) at/of/between:	Up (V)	U r.m.s. (V)	Frequency (kHz)#	Required cl (mm)	cl (mm)	Required cr (mm)	cr (mm)	
Basic/supplementary insulation								
--	--	--	--	--	--	--	--	
Reinforced insulation								
--	--	--	--	--	--	--	--	
Supplementary information: (#) Frequencies above and below 30 kHz Note 2: BI: basic insulation; SI: supplementary insulation; DI: double insulation; RI: reinforced insulation. *: According to 5.4.1.8.1 i), the working voltage to determine minimum creepage distances was measured after the ignition of the lamp.								

IEC 62368-1			
Clause	Requirement + Test	Result - Remark	Verdict

5.4.2.3	TABLE: Minimum Clearances distances using required withstand voltage			N/A
	Overvoltage Category (OV):			--
	Pollution Degree:			--
Clearance distanced between:		Required withstand voltage	Required cl (mm)	Measured cl (mm)
Basic / supplementary insulation				
--		--	--	--
Reinforced insulation				
--		--	--	--
Supplementary information: 1. BI: basic insulation; SI: supplementary insulation; DI: double insulation; RI: reinforced insulation;				

5.4.2.4	TABLE: Clearances based on electric strength test			N/A
Test voltage applied between:		Required cl (mm)	Test voltage (Kv) peak/ r.m.s. / d.c.	Breakdown Yes / No
--		--	--	--
Supplementary information: Not used the alternative method to determine the clearances.				

5.4.4.2, 5.4.4.5 c) 5.4.4.9	TABLE: Distance through insulation measurements					N/A
Distance through insulation di at/of:	Peak voltage (V)	Frequency (Hz)	Material	Required DTI (mm)	DTI (mm)	
--	--	--	--	--	--	
Supplementary information:						

5.4.9	TABLE: Electric strength tests			N/A
Test voltage applied between:		Voltage shape (AC, DC)	Test voltage (V)	Breakdown Yes / No
Functional:				
--		--	--	--
Basic/supplementary:				
--		--	--	--
Reinforced:				
--		--	--	--
Routine Tests:				

IEC 62368-1			
Clause	Requirement + Test	Result - Remark	Verdict

5.4.9	TABLE: Electric strength tests			N/A
Test voltage applied between:	Voltage shape (AC, DC)	Test voltage (V)	Breakdown Yes / No	
--	--	--	--	
Supplementary information:				

5.5.2.2	TABLE: Stored discharge on capacitors					N/A
Supply Voltage (V), Hz	Test Location	Operating Condition (N, S)	Switch position On or off	Measured Voltage (after 2 seconds)	ES Classification	
--	--	--	--	--	--	
Supplementary information: X-capacitors installed for testing are: -- <input type="checkbox"/> bleeding resistor rating: -- <input type="checkbox"/> ICX: Notes: 2. Test Location: Phase to Neutral; Phase to Phase; Phase to Earth; and/or Neutral to Earth B. Operating condition abbreviations: N – Normal operating condition (e.g., normal operation, or open fuse); S –Single fault condition OC- Opened circuit						

5.6.6.2	TABLE: Resistance of protective conductors and terminations				N/A
Accessible part	Test current (A)	Duration (min)	Voltage drop (V)	Resistance (Ω)	
--	--	--	--	--	
Supplementary information:					

IEC 62368-1			
Clause	Requirement + Test	Result - Remark	Verdict

5.7.2.2, 5.7.4	TABLE: Earthed accessible conductive part		N/A
Supply voltage	--	—	
Location	Test conditions specified in 6.1 of IEC 60990 or Fault Condition No in IEC 60990 clause 6.2.2.1 through 6.2.2.8, except for 6.2.2.7		Touch current (mA)
<u>Measured to PE</u>	1	<u>N/A</u>	
	2*	<u>N/A</u>	
	3	<u>N/A</u>	
	4	<u>N/A</u>	
	5	<u>N/A</u>	
	6	<u>N/A</u>	
	8	<u>N/A</u>	
Supplementary Information:			
Notes:			
[1] Supply voltage is the anticipated maximum Touch Voltage			
[2] Earthed neutral conductor [Voltage differences less than 1% or more]			
[3] Specify method used for measurement as described in IEC 60990 sub-clause 4.3			
[4] IEC60990, sub-clause 6.2.2.7, Fault 7 not applicable.			
[5] (*) IEC60990, sub-clause 6.2.2.2 is not applicable if switch or disconnect device (e.g., appliance coupler) provided.			
N: Normal condition, R: Reverse condition.			

IEC 62368-1			
Clause	Requirement + Test	Result - Remark	Verdict

6.2.2	Table: Electrical power sources (PS) measurements for classification					P
Source	Description	Measurement	Max Power after 3 s	Max Power after 5 s ^{*)}	PS Classification	
Power measurement for worst-case fault.	Internal circuit	Power (W) :	-	-	PS1(manufacturer declaration)	
		V _A (V) :	-	-		
		I _A (A) :	-	-		
Supplementary Information: SC: short circuit						

6.2.3.1	Table: Determination of Potential Ignition Sources (Arcing PIS)				N/A
Location	Open circuit voltage After 3 s (V _p)	Measured r.m.s current (I _{rms})	Calculated value (V _p x I _{rms})	Arcing PIS? Yes / No	
--	--	--	--	--	
Supplementary information: An Arcing PIS requires a minimum of 50 V (peak) a.c. or d.c. An Arcing PIS is established when the product of the open circuit voltage (V _p) and normal operating condition rms current (I _{rms}) is greater than 15.					

6.2.3.2	Table: Determination of Potential Ignition Sources (Resistive PIS)				N/A
Circuit Location (x-y)	Operating Condition (Normal / Describe Single Fault)	Measured wattage or VA During first 30 s (W / VA)	Measured wattage or VA After 30 s (W / VA)	Protective Circuit, Regulator, or PTC Operated? Yes / No (Comment)	Resistive PIS? Yes/No
--	--	--	--	--	--
Supplementary Information: All internal circuits were considered as resistive PIS. A combination of voltmeter, VA and ammeter IA may be used instead of a wattmeter. If a separate voltmeter and ammeter are used, the product of (VA x IA) is used to determine Resistive PIS classification. A Resistive PIS: (a) dissipates more than 15 W, measured after 30 s of normal operation, <u>or</u> (b) under single fault conditions has either a power exceeding 100 W measured immediately after the introduction of the fault if electronic circuits, regulators or PTC devices are used, or has an available power exceeding 15 W measured 30 s after introduction of the fault.					

8.5.5	TABLE: High Pressure Lamp		N/A
Description	Values	Energy Source Classification	
Lamp type		—	
Manufacturer		—	

IEC 62368-1			
Clause	Requirement + Test	Result - Remark	Verdict
Cat no.....:			—
Pressure (cold) (Mpa).....:			MS_
Pressure (operating) (Mpa).....:			MS_
Operating time (minutes).....:			—
Explosion method.....:			—
Max particle length escaping enclosure (mm) .:			MS_
Max particle length beyond 1 m (mm).....:			MS_
Overall result.....:			
Supplementary information:			

B.2.5	TABLE: Input test						P
U (V)	I (A)	I rated (A)	P (W)	P rated (W)	Fuse No	Ifuse (A)	Condition/status
3.6	0.45	--	--	--	--	--	Normal operation
Supplementary information: powered by battery							

B.3	TABLE: Abnormal operating condition tests							N/A
Ambient temperature (°C)					25.0		—	
Power source for EUT: Manufacturer, model/type, output rating .:					See cover page for details			—
Component No.	Abnormal Condition	Supply voltage, (V)	Test time (ms)	Fuse no.	Fuse current, (A)	T-couple	Temp. (°C)	Observation
-	-	-	-	-	-	-	-	-
Supplementary information: SC = short circuit. OL=overload								

IEC 62368-1			
Clause	Requirement + Test	Result - Remark	Verdict

B.4		TABLE: Fault condition tests						P
Ambient temperature (°C)		25.0						—
Power source for EUT: Manufacturer, model/type, output rating .:		See cover page for details						—
Component No.	Fault Condition	Supply voltage, (V)	Test time (ms)	Fuse no.	Fuse current, (A)	T-couple	Temp. (°C)	Observation
U7 pin6-2	Short circuit	3.6	10min	--	--	--	--	Unit shut down, no damaged, no hazard.
C6	Short circuit	3.6	10min	--	--	--	--	Unit shut down, no damaged, no hazard.
Battery output	Short circuit	3.6	10min	--	--	--	--	Unit shut down, no fire, no explosion, no damaged, no hazard.
Supplementary information: CD – Components damaged (list damaged components) NB – No indication of dielectric breakdown. NC – Cheesecloth remained intact. NT – Tissue paper remained intact.								

Annex M		TABLE: Batteries						N/A	
The tests of Annex M are applicable only when appropriate battery data is not available								--	
Is it possible to install the battery in a reverse polarity position?.....:		No						--	
	Non-rechargeable batteries			Rechargeable batteries					
	Discharging		Un-intentional charging	Charging		Discharging		Reversed charging	
	Meas. Current	Manuf. Specs.		Meas. Current	Manuf. Specs.	Meas. Current	Manuf. Specs.	Meas. Current	Manuf. Specs.
Max. current during normal condition	--	--	--	--	--	--	--	--	--
Max. current during fault condition	--	--	--	--	--	--	--	--	--
Test results:									
- Chemical leaks							--		Verdict
							--		--

IEC 62368-1			
Clause	Requirement + Test	Result - Remark	Verdict
- Explosion of the battery		--	--
- Emission of flame or expulsion of molten metal		--	--
- Electric strength tests of equipment after completion of tests		--	--
Supplementary information:			

Annex M.4	Table: Additional safeguards for equipment containing secondary lithium batteries				N/A
Battery/Cell No.	Test conditions	Measurements			Observation
		U (V)	I (A)	Temp (°C)	
1	Normal	--	--	--	--
2	Abnormal (after drop test)	--	--	--	--
Supplementary Information: SC = short circuit. For internal built-in lithium-ion battery pack:					
<ul style="list-style-type: none"> - Highest specified charging temperature: - Lowest specified charging temperature: - Maximum specified charging current: - Maximum specified charging voltage: 					
Battery identification	Charging at T_{lowest} (°C)	Observation	Charging at $T_{highest}$ (°C)	Observation	
li-ion battery	-	Charging current: -	-	Charging current: -	
Supplementary Information: The battery surface not exceeds the highest and lowest specified charging temperature under normal operating conditions, abnormal operating conditions or single fault conditions.					

Annex Q.1	TABLE: Circuits intended for interconnection with building wiring (LPS)				N/A	
Note: Measured UOC (V) with all load circuits disconnected:						
Output Circuit	Components	U _{oc} (V)	I _{sc} (A)		S (VA)	
			Meas.	Limit	Meas.	Limit
--	--	--	--	--	--	--
Supplementary Information:						

T.2, T.3, T.4, T.5	TABLE: Steady force test					P
Part/Location	Material	Thickness (mm)	Force (N)	Test Duration (sec)	Observation	

IEC 62368-1					
Clause	Requirement + Test			Result - Remark	Verdict
Top of enclosure	--	--	100N	5	No damaged, no hazards
Bottom of enclosure	--	--	100N	5	No damaged, no hazards
Side of enclosure	--	--	100N	5	No damaged, no hazards
Supplementary information:					

T.6, T.9	TABLE: Impact tests				N/A
Part/Location	Material	Thickness (mm)	Vertical distance (mm)	Observation	
--	--	--	--	--	
Supplementary information:					

T.7	TABLE: Drop tests				P
Part/Location	Material	Thickness (mm)	Drop Height (mm)	Observation	
Top	Plastic	--	1000	No damage, no hazards.	
Side	Plastic	--	1000	No damage, no hazards.	
Bottom	Plastic	--	1000	No damage, no hazards.	
Supplementary information:					

T.8	TABLE: Stress relief test					P
Part/Location	Material	Thickness (mm)	Oven Temperature (°C)	Duration (h)	Observation	
Whole product	Plastic	2.0	70	7	No damage, no hazards.	
Supplementary information:						

Attachment No. 1

IEC62368_1B – ATTACHMENT																																							
Clause	Requirement + Test	Result – Remark	Verdict																																				
TTACHMENT TO TEST REPORT IEC 62368-1 EUROPEAN GROUP DIFFERENCES AND NATIONAL DIFFERENCES (Audio/video, information and communication technology equipment – Part 1: Safety requirements)																																							
Differences according to : EN 62368-1:2014+A11:2017																																							
Attachment Form No. : EU_GD_IEC62368_1B_II																																							
Attachment Originator..... : Nemko AS																																							
Master Attachment..... : Date 2017-09-22																																							
Copyright © 2017 IEC System for Conformity Testing and Certification of Electrical Equipment (IECEE), Geneva, Switzerland. All rights reserved.																																							
	CENELEC COMMON MODIFICATIONS (EN)		--																																				
	Clauses, subclauses, notes, tables, figures and annexes which are additional to those in IEC 62368-1:2014 are prefixed "Z".																																						
CONTENTS	Add the following annexes: Annex ZA (normative) Normative references to international publications with their corresponding European publications Annex ZB (normative) Special national conditions Annex ZC (informative) A-deviations Annex ZD (informative) IEC and CENELEC code designations for flexible cords		P																																				
	Delete all the "country" notes in the reference document (IEC 62368-1:2014) according to the following list:		P																																				
	<table border="1" style="width: 100%; border-collapse: collapse;"> <tr> <td style="width: 15%;">0.2.1</td> <td style="width: 15%;">Note</td> <td style="width: 15%;">1</td> <td style="width: 15%;">Note 3</td> <td style="width: 15%;">4.1.15</td> <td style="width: 15%;">Note</td> </tr> <tr> <td>4.7.3</td> <td>Note 1 and 2</td> <td>5.2.2.2</td> <td>Note</td> <td>5.4.2.3.2.2 Table 13</td> <td>Note c</td> </tr> <tr> <td>5.4.2.3.2.4</td> <td>Note 1 and 3</td> <td>5.4.2.5</td> <td>Note 2</td> <td>5.4.5.1</td> <td>Note</td> </tr> <tr> <td>5.5.2.1</td> <td>Note</td> <td>5.5.6</td> <td>Note</td> <td>5.6.4.2.1</td> <td>Note 2 and 3</td> </tr> <tr> <td>5.7.5</td> <td>Note</td> <td>5.7.6.1</td> <td>Note 1 and 2</td> <td>10.2.1 Table 39</td> <td>Note 2, 3 and 4</td> </tr> <tr> <td>10.5.3</td> <td>Note 2</td> <td>10.6.2.1</td> <td>Note 3</td> <td>F.3.3.6</td> <td>Note 3</td> </tr> </table>			0.2.1	Note	1	Note 3	4.1.15	Note	4.7.3	Note 1 and 2	5.2.2.2	Note	5.4.2.3.2.2 Table 13	Note c	5.4.2.3.2.4	Note 1 and 3	5.4.2.5	Note 2	5.4.5.1	Note	5.5.2.1	Note	5.5.6	Note	5.6.4.2.1	Note 2 and 3	5.7.5	Note	5.7.6.1	Note 1 and 2	10.2.1 Table 39	Note 2, 3 and 4	10.5.3	Note 2	10.6.2.1	Note 3	F.3.3.6	Note 3
0.2.1	Note	1	Note 3	4.1.15	Note																																		
4.7.3	Note 1 and 2	5.2.2.2	Note	5.4.2.3.2.2 Table 13	Note c																																		
5.4.2.3.2.4	Note 1 and 3	5.4.2.5	Note 2	5.4.5.1	Note																																		
5.5.2.1	Note	5.5.6	Note	5.6.4.2.1	Note 2 and 3																																		
5.7.5	Note	5.7.6.1	Note 1 and 2	10.2.1 Table 39	Note 2, 3 and 4																																		
10.5.3	Note 2	10.6.2.1	Note 3	F.3.3.6	Note 3																																		
	For special national conditions, see Annex ZB.		P																																				
1	Add the following note: NOTE Z1 The use of certain substances in electrical and electronic equipment is restricted within the EU: see Directive 2011/65/EU.		P																																				

IEC 62368-1			
Clause	Requirement + Test	Result - Remark	Verdict
4.Z1	<p>Add the following new subclause after 4.9:</p> <p>To protect against excessive current, short-circuits and earth faults in circuits connected to an a.c. mains, protective devices shall be included either as integral parts of the equipment or as parts of the building installation, subject to the following, a), b) and c):</p> <p>a) except as detailed in b) and c), protective devices necessary to comply with the requirements of B.3.1 and B.4 shall be included as parts of the equipment;</p> <p>b) for components in series with the mains input to the equipment such as the supply cord, appliance coupler, r.f.i. filter and switch, short-circuit and earth fault protection may be provided by protective devices in the building installation;</p> <p>c) it is permitted for pluggable equipment type B or permanently connected equipment, to rely on dedicated overcurrent and short-circuit protection in the building installation, provided that the means of protection, e.g. fuses or circuit breakers, is fully specified in the installation instructions.</p> <p>If reliance is placed on protection in the building installation, the installation instructions shall so state, except that for pluggable equipment type A the building installation shall be regarded as providing protection in accordance with the rating of the wall socket outlet.</p>		P
5.4.2.3.2.4	<p>Add the following to the end of this subclause:</p> <p>The requirement for interconnection with external circuit is in addition given in EN 50491-3:2009.</p>		N/A
10.2.1	<p>Add the following to ^{c)} and ^{d)} in table 39:</p> <p>For additional requirements, see 10.5.1.</p>		N/A

IEC 62368-1			
Clause	Requirement + Test	Result - Remark	Verdict
10.5.1	<p>Add the following after the first paragraph: <i>For RS 1 compliance is checked by measurement under the following conditions:</i></p> <p><i>In addition to the normal operating conditions, all controls adjustable from the outside by hand, by any object such as a tool or a coin, and those internal adjustments or presets which are not locked in a reliable manner, are adjusted so as to give maximum radiation whilst maintaining an intelligible picture for 1 h, at the end of which the measurement is made.</i></p> <p>NOTE Z1 Soldered joints and paint lockings are examples of adequate locking.</p> <p><i>The dose-rate is determined by means of a radiation monitor with an effective area of 10 cm², at any point 10 cm from the outer surface of the apparatus.</i></p> <p><i>Moreover, the measurement shall be made under fault conditions causing an increase of the high-voltage, provided an intelligible picture is maintained for 1 h, at the end of which the measurement is made.</i></p> <p><i>For RS1, the dose-rate shall not exceed 1 µSv/h taking account of the background level.</i></p> <p>NOTE Z2 These values appear in Directive 96/29/Euratom of 13 May 1996.</p>		N/A
10.6.1	<p>Add the following paragraph to the end of the subclause: EN 71-1:2011, 4.20 and the related tests methods and measurement distances apply.</p>		N/A
10.Z1	<p>Add the following new subclause after 10.6.5. 10.Z1 Non-ionizing radiation from radio frequencies in the range 0 to 300 GHz</p> <p>The amount of non-ionizing radiation is regulated by European Council Recommendation 1999/519/EC of 12 July 1999 on the limitation of exposure of the general public to electromagnetic fields (0 Hz to 300 GHz).</p> <p>For intentional radiators, ICNIRP guidelines should be taken into account for Limiting Exposure to Time-Varying Electric, Magnetic, and Electromagnetic Fields (up to 300 GHz). For hand-held and body-mounted devices, attention is drawn to EN 50366 and EN 50566</p>		N/A
G.7.1	<p>Add the following note: NOTE Z1 The harmonized code designations corresponding to the IEC cord types are given in Annex ZD.</p>		P

IEC 62368-1			
Clause	Requirement + Test	Result - Remark	Verdict
Bibliography	<p>Add the following standards:</p> <p>Add the following notes for the standards indicated:</p> <p>IEC 60130-9 NOTE Harmonized as EN 60130-9.</p> <p>IEC 60269-2 NOTE Harmonized as HD 60269-2.</p> <p>IEC 60309-1 NOTE Harmonized as EN 60309-1.</p> <p>IEC 60364 NOTE some parts harmonized in HD 384/HD 60364 series.</p> <p>IEC 60601-2-4 NOTE Harmonized as EN 60601-2-4.</p> <p>IEC 60664-5 NOTE Harmonized as EN 60664-5.</p> <p>IEC 61032:1997 NOTE Harmonized as EN 61032:1998 (not modified).</p> <p>IEC 61508-1 NOTE Harmonized as EN 61508-1.</p> <p>IEC 61558-2-1 NOTE Harmonized as EN 61558-2-1.</p> <p>IEC 61558-2-4 NOTE Harmonized as EN 61558-2-4.</p> <p>IEC 61558-2-6 NOTE Harmonized as EN 61558-2-6.</p> <p>IEC 61643-1 NOTE Harmonized as EN 61643-1.</p> <p>IEC 61643-21 NOTE Harmonized as EN 61643-21.</p> <p>IEC 61643-311 NOTE Harmonized as EN 61643-311.</p> <p>IEC 61643-321 NOTE Harmonized as EN 61643-321.</p> <p>IEC 61643-331 NOTE Harmonized as EN 61643-331.</p>		P
ZB	ANNEX ZB, SPECIAL NATIONAL CONDITIONS (EN)		P
4.1.15	<p>Denmark, Finland, Norway and Sweden</p> <p>To the end of the subclause the following is added:</p> <p>Class I pluggable equipment type A intended for connection to other equipment or a network shall, if safety relies on connection to reliable earthing or if surge suppressors are connected between the network terminals and accessible parts, have a marking stating that the equipment shall be connected to an earthed mains socket-outlet.</p> <p>The marking text in the applicable countries shall be as follows:</p> <p>In Denmark: "Apparatets stikprop skal tilsluttes en stikkontakt med jord som giver forbindelse til stikproppens jord."</p> <p>In Finland: "Laite on liitettävä suojakoskettimilla varustettuun pistorasiaan"</p> <p>In Norway: "Apparatet må tilkoples jordet stikkontakt"</p> <p>In Sweden: "Apparaten skall anslutas till jordat uttag"</p>		N/A
4.7.3	<p>United Kingdom</p> <p>To the end of the subclause the following is added:</p> <p>The torque test is performed using a socket-outlet complying with BS 1363, and the plug part shall be assessed to the relevant clauses of BS 1363. Also see Annex G.4.2 of this annex</p>		N/A

IEC 62368-1			
Clause	Requirement + Test	Result - Remark	Verdict
5.2.2.2	<p>Denmark</p> <p>After the 2nd paragraph add the following: A warning (marking safeguard) for high touch current is required if the touch current exceeds the limits of 3,5 mA a.c. or 10 mA d.c.</p>		N/A
5.4.11.1 and Annex G	<p>Finland and Sweden</p> <p>To the end of the subclause the following is added: For separation of the telecommunication network from earth the following is applicable: If this insulation is solid, including insulation forming part of a component, it shall at least consist of either</p> <ul style="list-style-type: none"> • two layers of thin sheet material, each of which shall pass the electric strength test below, or • one layer having a distance through insulation of at least 0,4 mm, which shall pass the electric strength test below. <p>If this insulation forms part of a semiconductor component (e.g. an optocoupler), there is no distance through insulation requirement for the insulation consisting of an insulating compound completely filling the casing, so that clearances and creepage distances do not exist, if the component passes the electric strength test in accordance with the compliance clause below and in addition</p> <ul style="list-style-type: none"> • passes the tests and inspection criteria of 5.4.8 with an electric strength test of 1,5 kV multiplied by 1,6 (the electric strength test of 5.4.9 shall be performed using 1,5 kV), and • is subject to routine testing for electric strength during manufacturing, using a test voltage of 1,5kV. <p>It is permitted to bridge this insulation with a capacitor complying with EN 60384-14:2005, subclass Y2.</p> <p>A capacitor classified Y3 according to EN 60384-14:2005, may bridge this insulation under the following conditions:</p> <ul style="list-style-type: none"> • the insulation requirements are satisfied by having a capacitor classified Y3 as defined by EN 60384-14, which in addition to the Y3 testing, is tested with an impulse test of 2,5 kV defined in 5.4.11; • the additional testing shall be performed on all the test specimens as described in EN 60384-14; <p>the impulse test of 2,5 kV is to be performed before the endurance test in EN 60384-14, in the sequence of tests as described in EN 60384-14.</p>		N/A

IEC 62368-1			
Clause	Requirement + Test	Result - Remark	Verdict
5.5.2.1	<p>Norway After the 3rd paragraph the following is added: Due to the IT power system used, capacitors are required to be rated for the applicable line-to-line voltage (230 V).</p>		N/A
5.5.6	<p>Finland, Norway and Sweden To the end of the subclause the following is added: Resistors used as basic safeguard or bridging basic insulation in class I pluggable equipment type A shall comply with G.10.1 and the test of G.10.2.</p>		N/A
5.6.1	<p>Denmark Add to the end of the subclause Due to many existing installations where the socket-outlets can be protected with fuses with higher rating than the rating of the socket-outlets the protection for pluggable equipment type A shall be an integral part of the equipment. <i>Justification:</i> In Denmark an existing 13 A socket outlet can be protected by a 20 A fuse.</p>		N/A
5.6.4.2.1	<p>Ireland and United Kingdom After the indent for pluggable equipment type A, the following is added: – the protective current rating is taken to be 13 A, this being the largest rating of fuse used in the mains plug.</p>		N/A
5.6.5.1	<p>To the second paragraph the following is added: The range of conductor sizes of flexible cords to be accepted by terminals for equipment with a rated current over 10 A and up to and including 13 A is: 1,25 mm² to 1,5 mm² in cross-sectional area.</p>		N/A
5.7.5	<p>Denmark To the end of the subclause the following is added: The installation instruction shall be affixed to the equipment if the protective conductor current exceeds the limits of 3,5 mA a.c. or 10 mA d.c.</p>		N/A

IEC 62368-1			
Clause	Requirement + Test	Result - Remark	Verdict
5.7.6.1	<p>Norway and Sweden</p> <p>To the end of the subclause the following is added:</p> <p>The screen of the television distribution system is normally not earthed at the entrance of the building and there is normally no equipotential bonding system within the building. Therefore the protective earthing of the building installation needs to be isolated from the screen of a cable distribution system.</p> <p>It is however accepted to provide the insulation external to the equipment by an adapter or an interconnection cable with galvanic isolator, which may be provided by a retailer, for example.</p> <p>The user manual shall then have the following or similar information in Norwegian and Swedish language respectively, depending on in what country the equipment is intended to be used in:</p> <p>“Apparatus connected to the protective earthing of the building installation through the mains connection or through other apparatus with a connection to protective earthing – and to a television distribution system using coaxial cable, may in some circumstances create a fire hazard. Connection to a television distribution system therefore has to be provided through a device providing electrical isolation below a certain frequency range (galvanic isolator, see EN 60728-11)”</p> <p>NOTE In Norway, due to regulation for CATV-installations, and in Sweden, a galvanic isolator shall provide electrical insulation below 5 MHz. The insulation shall withstand a dielectric strength of 1,5 kV r.m.s., 50 Hz or 60 Hz, for 1 min.</p> <p>Translation to Norwegian (the Swedish text will also be accepted in Norway):</p> <p>“Apparater isa I kopleet til beskyttelsesjord via nettplugg og/eller via annet jordtilkopleet utstyr – isa tilkopleet et koaksialbasert kabel-TV nett, kan forårsake brannfare. For å unngå dette skal det ved tilkopling av apparater til kabel-TV nett isa llers en galvanisk isolator mellom apparatet og kabel-TV nettet.”</p> <p>Translation to Swedish:</p> <p>”Apparater som är kopplad till skyddsjord via jordat vägguttag och/eller via annan utrustning och samtidigt är kopplad till kabel-TV nät kan I isa fall medföra risk för brand. För att undvika detta skall vid anslutning av apparaten till kabel-TV nät galvanisk isolator finnas mellan apparaten och kabel-TV nätet.”</p>		N/A

IEC 62368-1			
Clause	Requirement + Test	Result - Remark	Verdict
5.7.6.2	<p>Denmark</p> <p>To the end of the subclause the following is added: The warning (marking safeguard) for high touch current is required if the touch current or the protective current exceed the limits of 3,5 mA .</p>		N/A
B.3.1 and B.4	<p>Ireland and United Kingdom</p> <p>The following is applicable: To protect against excessive currents and short-circuits in the primary circuit of direct plug-in equipment, tests according to Annexes B.3.1 and B.4 shall be conducted using an external miniature circuit breaker complying with EN 60898-1, Type B, rated 32A. If the equipment does not pass these tests, suitable protective devices shall be included as an integral part of the direct plug-in equipment, until the requirements of Annexes B.3.1 and B.4 are met</p>		N/A
G.4.2	<p>Denmark</p> <p>To the end of the subclause the following is added: Supply cords of single phase appliances having a rated current not exceeding 13 A shall be provided with a plug according to DS 60884-2-D1:2011. CLASS I EQUIPMENT provided with socket-outlets with earth contacts or which are intended to be used in locations where protection against indirect contact is required according to the wiring rules shall be provided with a plug in accordance with standard sheet DK 2-1a or DK 2-5a. If a single-phase equipment having a RATED CURRENT exceeding 13 A or if a poly-phase equipment is provided with a supply cord with a plug, this plug shall be in accordance with the standard sheets DK 6-1a in DS 60884-2-D1 or EN 60309-2. Mains socket outlets intended for providing power to Class II apparatus with a rated current of 2,5 A shall be in accordance DS 60884-2-D1:2011 standard sheet DKA 1-4a. Other current rating socket outlets shall be in compliance with Standard Sheet DKA 1-3a or DKA 1-1c. Mains socket-outlets with earth shall be in compliance with DS 60884-2-D1:2011 Standard Sheet DK 1-3a, DK 1-1c, DK1-1d, DK 1-5a or DK 1-7a <i>Justification:</i> Heavy Current Regulations, Section 6c</p>		N/A

IEC 62368-1			
Clause	Requirement + Test	Result - Remark	Verdict
G.4.2	<p>United Kingdom</p> <p>To the end of the subclause the following is added: The plug part of direct plug-in equipment shall be assessed to BS 1363: Part 1, 12.1, 12.2, 12.3, 12.9, 12.11, 12.12, 12.13, 12.16, and 12.17, except that the test of 12.17 is performed at not less than 125 °C. Where the metal earth pin is replaced by an Insulated Shutter Opening Device (ISOD), the requirements of clauses 22.2 and 23 also apply.</p>		N/A
G.7.1	<p>United Kingdom</p> <p>To the first paragraph the following is added: Equipment which is fitted with a flexible cable or cord and is designed to be connected to a mains socket conforming to BS 1363 by means of that flexible cable or cord shall be fitted with a 'standard plug' in accordance with the Plugs and Sockets etc (Safety) Regulations 1994, Statutory Instrument 1994 No. 1768, unless exempted by those regulations.</p> <p>NOTE "Standard plug" is defined in SI 1768:1994 and essentially means an approved plug conforming to BS 1363 or an approved conversion plug.</p>		N/A
G.7.1	<p>Ireland</p> <p>To the first paragraph the following is added: Apparatus which is fitted with a flexible cable or cord shall be provided with a plug in accordance with Statutory Instrument 525: 1997, "13 A Plugs and Conversion Adapters for Domestic Use Regulations: 1997. S.I. 525 provides for the recognition of a standard of another Member State which is equivalent to the relevant Irish Standard</p>		N/A
G.7.2	<p>Ireland and United Kingdom</p> <p>To the first paragraph the following is added: A power supply cord with a conductor of 1,25 mm² is allowed for equipment which is rated over 10 A and up to and including 13 A.</p>		N/A

IEC 62368-1			
Clause	Requirement + Test	Result - Remark	Verdict
ZC	ANNEX ZC, NATIONAL DEVIATIONS (EN)		N/A
10.5.2	<p>Germany</p> <p>The following requirement applies:</p> <p>For the operation of any cathode ray tube intended for the display of visual images operating at an acceleration voltage exceeding 40 kV, authorization is required, or application of type approval (Bauartzulassung) and marking.</p> <p><i>Justification:</i></p> <p>German ministerial decree against ionizing radiation (Röntgenverordnung), in force since 2002-07-01, implementing the European Directive 96/29/EURATOM.</p> <p>NOTE Contact address: Physikalisch-Technische Bundesanstalt, Bundesallee 100, D-38116 Braunschweig, Tel.: Int +49-531-592-6320, Internet: http://www.ptb.de</p>		N/A

Note: Before placing the products in the different countries, the manufacturer must ensure that:

1. Operating Instructions, Ratings Labels and Warnings Labels written in an Accepted or Official Language of the county in question.
2. The equipment complies with the National Standards and/or Electrical Codes of the country in question.

Attachment No. 2

Details of: Outside overview

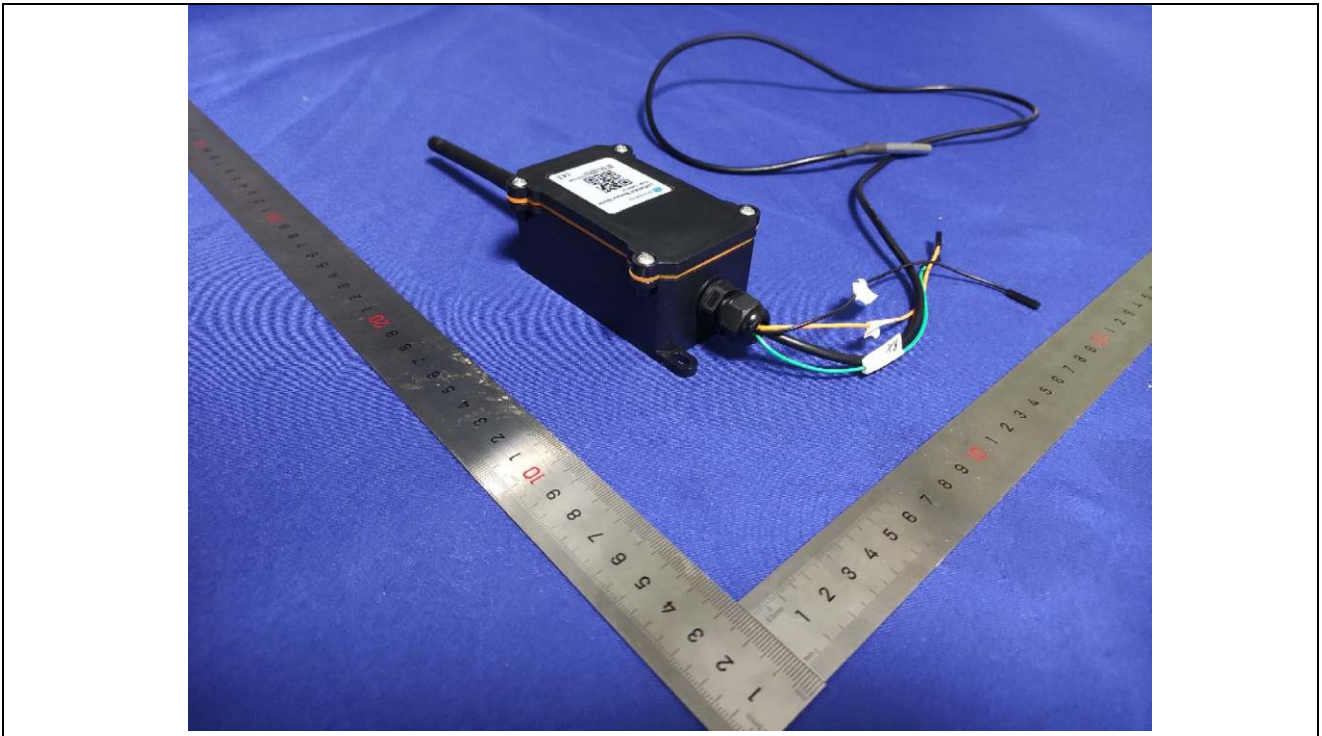

Details of: Outside overview

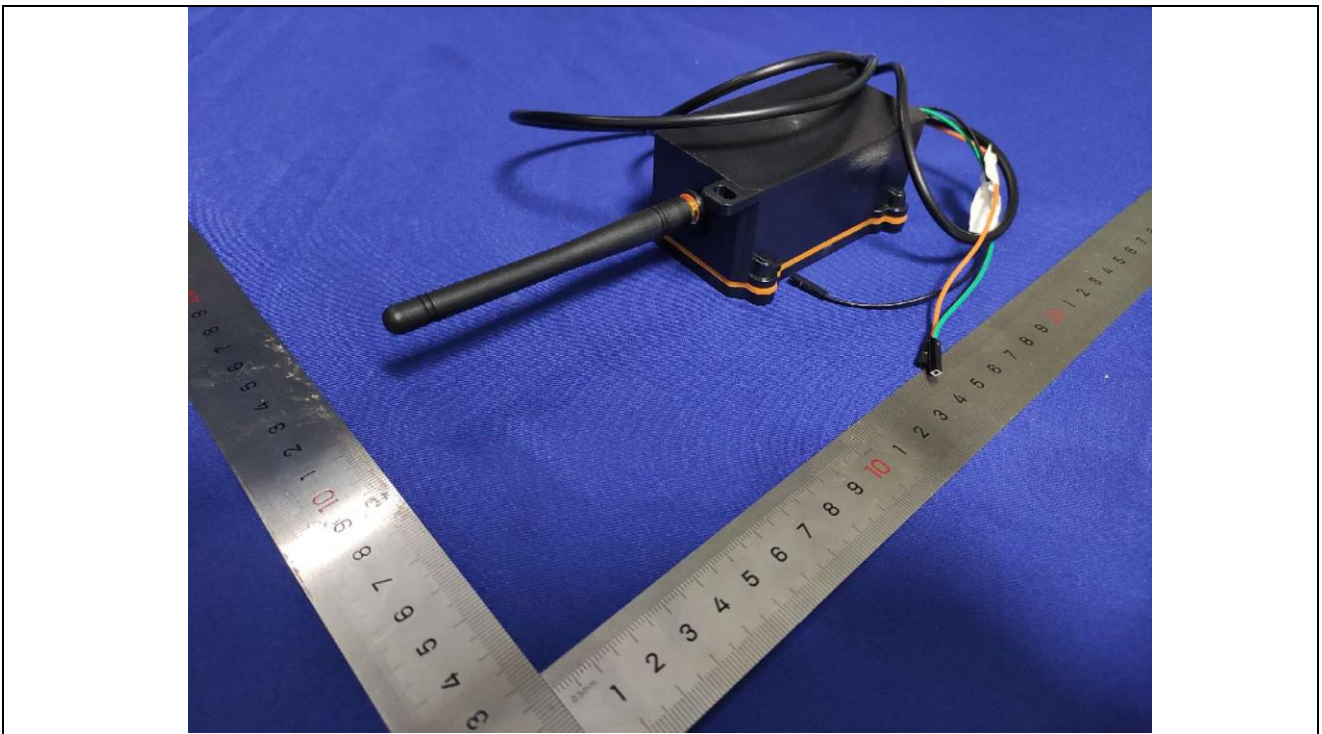

Attachment No. 2

Details of: Outside view

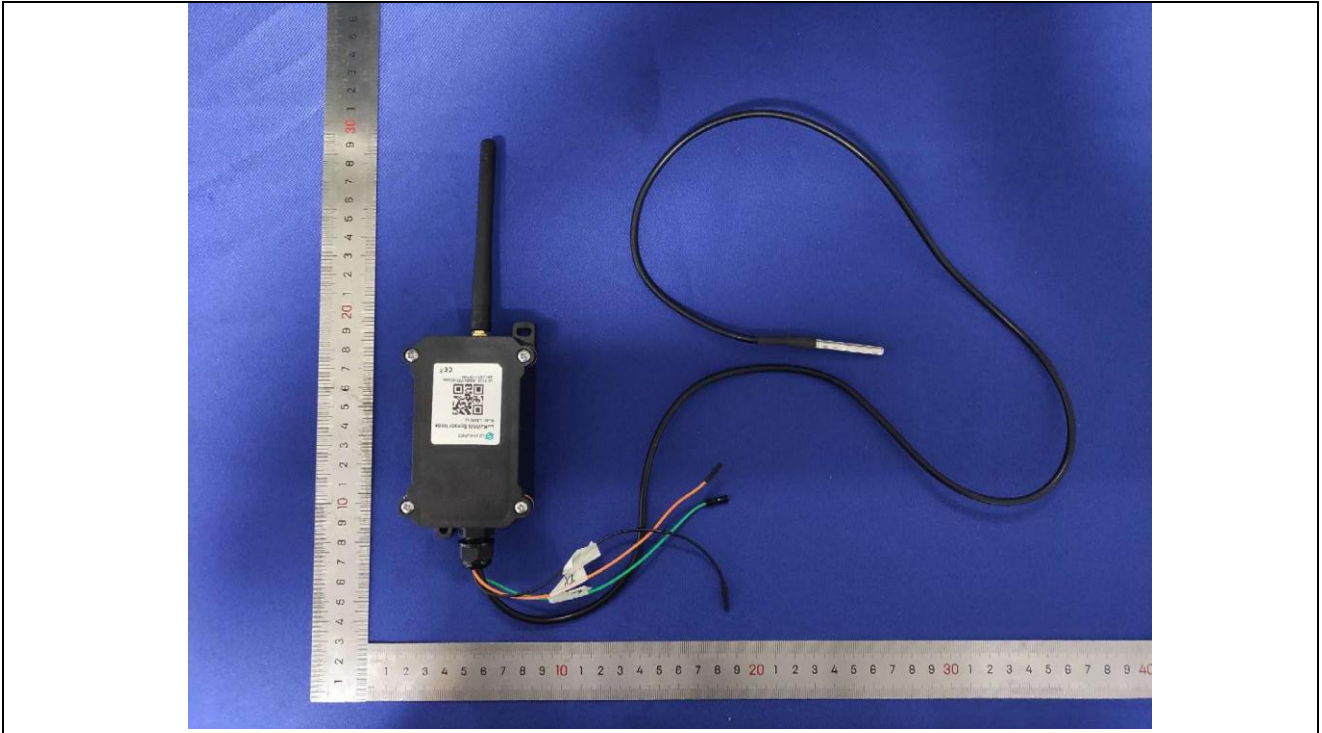

Details of: Outside view

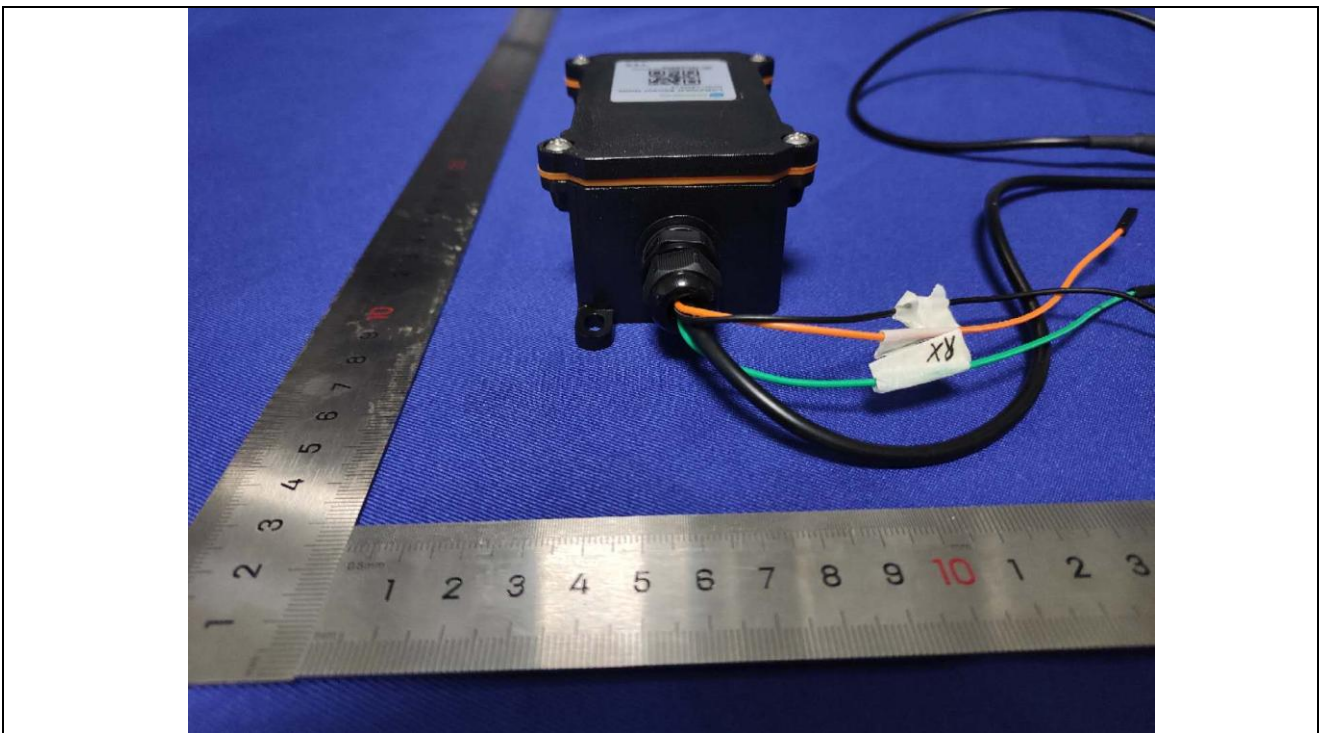

Attachment No. 2

Details of: inside view

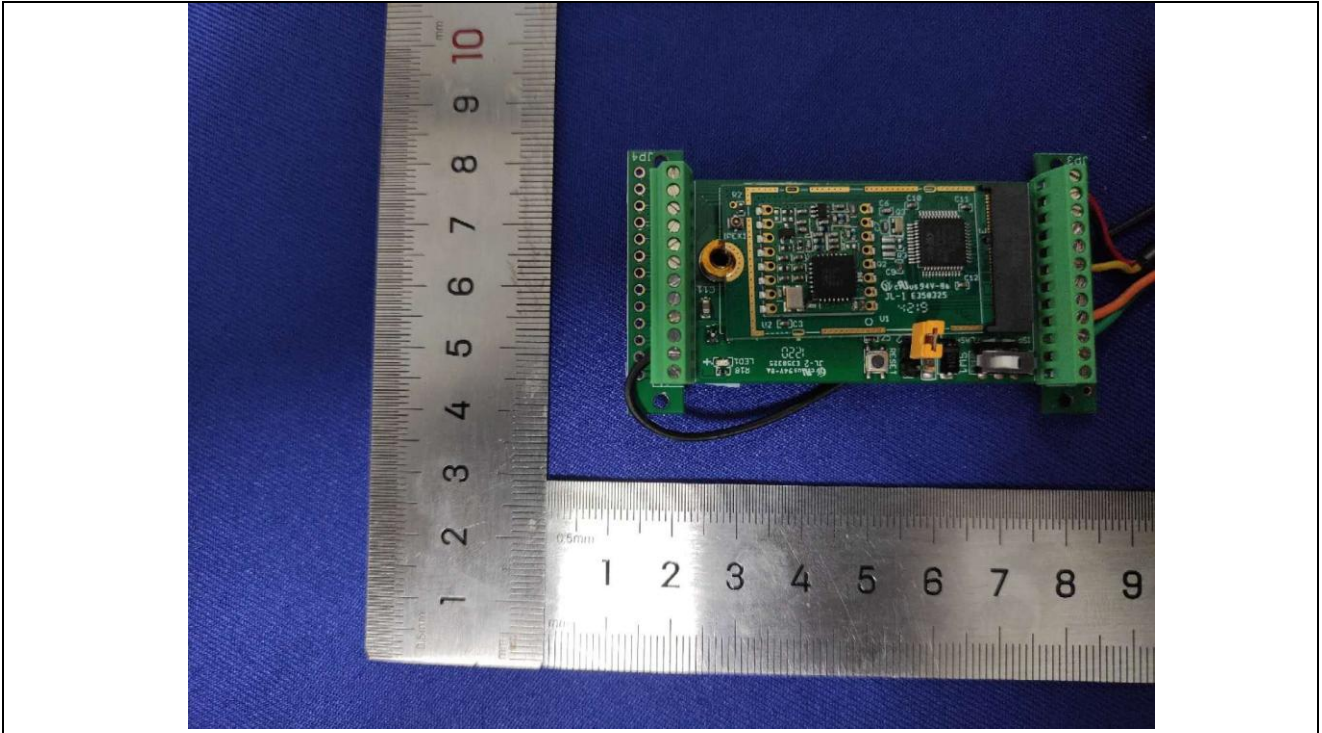

Details of: inside view

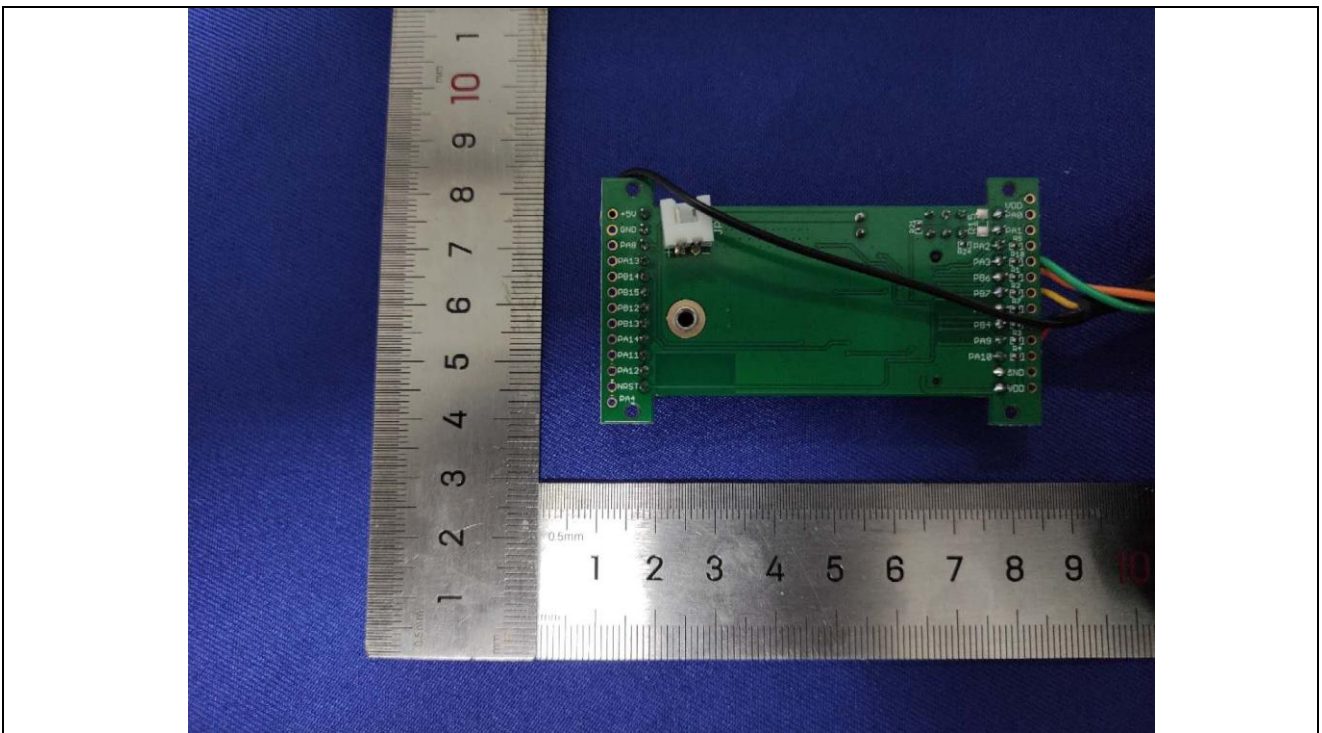

End of report